

B O X E S B O O K

specialist in folder gluer for over 70 years

VEGA

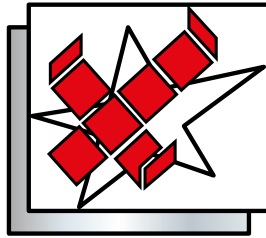

VEGGA
G R O U P

P R E F A Z I O N E

Questo libro è stato realizzato con lo scopo di guidarLa nell'**identificazione dei dispositivi** studiati da Vega, montabili sulle macchine VEGA anche successivamente all'acquisto, necessari per realizzare le scatole riportate nelle sezioni che seguono.

Nella **legenda** sono spiegati i significati delle lettere che identificano i dispositivi necessari. Le informazioni presenti in questo documento sono fornite a titolo indicativo e seguono la continua evoluzione delle nostre piega incollatrici.

Il nostro ufficio tecnico è a disposizione per lo **studio** e la **realizzazione** di **dispositivi ad-hoc** per scatole che non rientrano nelle tipologie rappresentate.

P R E F A C E

This book has been done in order to help you in **identifying** the **attachments** realized by VEGA to be installed on VEGA machines also later on, necessary to make the boxes mentioned in the following sections.

The **legend** explains the meaning of the letters that identify the requested attachments.

The information given in this document is supplied approximately and follows the continuous evolution of our folder-gluer.

Our Technical Department is at your full disposal for **studying** and **realizing suitable devices** for the boxes not shown in this book.

La copia o la distribuzione di questo documento è vietata a meno di autorizzazione scritta di Vega s.r.l. Alcune scatole sono protette da brevetto, pertanto possono essere prodotte soltanto su licenza.

Copy or distribution of this document not admitted unless written authorization is supplied by Vega s.r.l. Some kind of boxes shown herewith are under patent, therefore they can be only realized on licence.

A S S O C I A Z I O N I A C O D I C I F E F C O

F E F C O C O D E S A S S O C I A T I O N S

CODICE FEFCO FEFCO CODE	CODICE VEGA VEGA CODE	CODICE VEGA SIMILE SIMILAR VEGA CODE
0100	--	
0110	--	
0200		1.17
0201	1.01	
0202	1.01	
0203	1.01	
0204		1.01
0205	1.01	
0206		1.01
0207	--	
0208	--	
0209	1.01	
0210	1.09	
0211		1.04
0212		1.14
0214		1.01
0215	1.05	
0216		1.05
0217		1.05
0218		1.34

CODICE FEFCO FEFCO CODE	CODICE VEGA VEGA CODE	CODICE VEGA SIMILE SIMILAR VEGA CODE
0225		1.44
0226	--	
0227	1.32	
0228		10.19-10.20
0229		1.01
0230	1.26	
0231		1.26
0300	--	
0301	--	
0302	--	
0303	9.30	
0304	9.01	
0306	--	
0307	--	
0308	9.42	
0309	9.40	
0310	--	
0312	--	
0313	--	
0314	--	

CODICE FEFCO FEFCO CODE	CODICE VEGA VEGA CODE	CODICE VEGA SIMILE SIMILAR VEGA CODE
0320		1.17
0321		1.35
0322		4.01
0323		4.01
0325	--	
0330	--	
0331	--	
0350	--	
0351	--	
0352	--	
0400	--	
0401	--	
0402	--	
0403	--	
0404	--	
0405	--	
0406		1.01
0409	1.26	
0410		1.01
0411	1.26	

A S S O C I A Z I O N I A C O D I C I F E F C O

F E F C O C O D E S A S S O C I A T I O N S

CODICE FEFCO FEFCO CODE	CODICE VEGA VEGA CODE	CODICE VEGA SIMILE SIMILAR VEGA CODE
0412	--	
0413	--	
0415	--	
0416	--	
0420	--	
0421	--	
0422	--	
0423	--	
0424	--	
0425	--	
0426	--	
0427	--	
0428	--	
0429	--	
0430	--	
0431	--	
0432	--	
0433	--	
0434	--	
0435	--	

CODICE FEFCO FEFCO CODE	CODICE VEGA VEGA CODE	CODICE VEGA SIMILE SIMILAR VEGA CODE
0436	--	
0437	--	
0440	--	
0441	--	
0442	--	
0443	--	
0444	--	
0445	--	
0446	--	
0447	--	
0448	9.42	
0449	9.40	
0450	9.30	
0451	9.01	
0452	--	
0453	--	
0454	--	
0455	--	
0456	--	
0457	--	

CODICE FEFCO FEFCO CODE	CODICE VEGA VEGA CODE	CODICE VEGA SIMILE SIMILAR VEGA CODE
0458	--	
0459	--	
0460	--	
0470	--	
0471	--	
0472	--	
0473	--	
0501	1.24	
0502	1.24	
0503	1.24	
0504	--	
0505	--	
0507	--	
0509	--	
0510	--	
0511	--	
0512	--	
0601	--	
0602	--	
0605	--	

A S S O C I A Z I O N I A C O D I C I F E F C O

F E F C O C O D E S A S S O C I A T I O N S

CODICE FEFCO FEFCO CODE	CODICE VEGA VEGA CODE	CODICE VEGA SIMILE SIMILAR VEGA CODE
0606	--	
0607	--	
0608	--	
0610	--	
0615	--	
0616	--	
0620	--	
0621	--	
0700	2.15	
0701	3.02	
0703		3.02
0711		3.21
0712		2.01
0713	2.01	
0714		2.19
0715	10.29	
0716		10.31
0717	10.44	
0718	9.41	
0747	10.45	

CODICE FEFCO FEFCO CODE	CODICE VEGA VEGA CODE	CODICE VEGA SIMILE SIMILAR VEGA CODE
0748	9.02	
0751	9.28	
0752	--	
0759	9.07	
0761		9.21
0770		9.01
0771	--	
0772	--	
0773	--	
0774	--	
0900	--	
0901	--	
0902	--	
0903	--	
0904	--	
0905	--	
0906	--	
0907	--	
0908	--	
0909	--	

CODICE FEFCO FEFCO CODE	CODICE VEGA VEGA CODE	CODICE VEGA SIMILE SIMILAR VEGA CODE
0910	--	
0911	--	
0913	--	
0914	--	
0920	--	
0921	--	
0929	--	
0930	--	
0931	--	
0932	--	
0933	--	
0934	--	
0935	--	
0940	--	
0941	--	
0942	--	
0943	--	
0944	--	
0945	--	
0946	--	

A S S O C I A Z I O N I A C O D I C I F E F C O

F E F C O C O D E S A S S O C I A T I O N S

CODICE FEFCO FEFCO CODE	CODICE VEGA VEGA CODE	CODICE VEGA SIMILE SIMILAR VEGA CODE
0947	--	
0948	--	
0949	--	
0950	--	
0951	--	

CODICE FEFCO FEFCO CODE	CODICE VEGA VEGA CODE	CODICE VEGA SIMILE SIMILAR VEGA CODE
0965	--	
0966	--	
0967	--	
0970	--	
0971	--	

CODICE FEFCO FEFCO CODE	CODICE VEGA VEGA CODE	CODICE VEGA SIMILE SIMILAR VEGA CODE
0972	--	
0973	--	
0974	--	
0975	--	
0976	--	

L E G E N D A

L E G E N D

- A** Macchina Standard
Standard Machine
- B** Dispositivo scatole con fondo a chiusura automatica
Crash lock bottom device
- C** Incollatori Superiori (a spruzzo o a disco)
Upper gluing unit (spray or wheel)
- D** Incollatore inferiore destro
Right lower gluing unit
- E** Dispositivo fondo automatico rovesciato
Reverse crash lock bottom device
- F** Incollatori superiori in rompipiega (a spruzzo o a disco)
Upper gluing unit in prefolding (spray or wheel)
- G** Dispositivo per scatole a doppia parete
Double wall device
- H** Dispositivo per buste dischi
Record sleeve device
- I** Dispositivo per buste speciali (invio campioni indispensabile)
Special envelope device (please submit samples)
- J** Dispositivo per buste a soffietto
Bellows (Z-fold) type sleeve device
- K** Incollatore inferiore sinistro
Left lower gluing unit
- L** Dispositivo per scatole coniche (invio campioni indispensabile)
Conical box device (please submit samples)
- M** Dispositivo per contenitori conici
Conical sleeve device
- N** Dispositivo per scatole con 4 angoli incollati
Four corners glued box device
- O** Dispositivo per scatole con 6 angoli incollati
Six corners glued box device
- P** Dispositivo per scatole esagonali
Exagonal box device
- Q** Incollatori a spruzzo vinilici e/o hot melt
Cold and/or hot-melt spray gluing unit
- R** Dispositivo per scatole a scomparti
Partitions box device
- S** Accessorio per scatole speciali (invio campioni indispensabile)
Special box attachments (please submit samples)
- T** Modulo aggiuntivo
Additional module
- U** Modulo aggiuntivo con doppia parete
Additional module with double wall
- V** Modulo aggiuntivo con piega posteriore
Additional module with rear fold
- W** Dispositivo per scatole con dorso
Capacity folders device

TABELLA MODELLI - ACCESSORI

MODELS - ACCESSORIES CHART

TIPI DI SCATOLE BOXES TYPE	VEGA AQUILA 62 82 102	VEGA FRECCIA 60	VEGA POLARIS 90 110	VEGA PULSAR 110 130 145	VEGA ALTAIR 160 200 240 290	VEGA AF 165	VEGA ADF 160 200 240 290
1.01	A	A	A	A	A-K		
1.02	A	A	A	A	A-K		
1.03	A	A	A	A	A-K		
1.04	A	A	A	A	A-K		
1.05	A	A	A	A	A-K		
1.06	A	A	A	A	A-K		
1.07	A	A	A	A	A-K		
1.08	A	A	A	A	A-K		
1.09	A	A	A	A	A-K		
1.10	A	A	A	A	A-K		
1.11	A	A	A	A	A-K		
1.12	A	A	A	A	A-K		
1.13	A	A	A	A	A-K		
1.14	A	A	A	A	A-K		
1.15	A	A	A	A	A-K		
1.16	A	A	A	A	A-K		
1.17	A	A	A	A	A-K		
1.18	A	A	A	A	A-K		
1.19	A	A	A	A	A-K		
1.20	A	A	A	A	A-K		

TIPI DI SCATOLE BOXES TYPE	VEGA AQUILA 62 82 102	VEGA FRECCIA 60	VEGA POLARIS 90 110	VEGA PULSAR 110 130 145	VEGA ALTAIR 160 200 240 290	VEGA AF 165	VEGA ADF 160 200 240 290
1.21	A	A	A	A	A-K		
1.22	A	A	A	A	A-K		
1.23	A	A	A	A	A-K		
1.24	A	A	A	A	A-K		
1.25	A	A	A	A	A-K		
1.26	A	A	A	A	A-K		
1.27	A	A	A	A	A-K		
1.28	A	A	A	A	A-K		
1.29	A	A	A	A	A-K		
1.30	A	A	A	A	A-K		
1.31	A	A	A	A	A-K		
1.32	A	A	A	A	A-K		
1.33	A	A	A	A	A-K		
1.34	A	A	A	A	A-K		
1.35	A	A	A	A	A-K		
1.36	A	A	A	A	A-K		
1.37	A	A	A	A	A-K		
1.38	A	A	A	A	A-K		
1.39	A	A	A	A	A-K		
1.40	A	A	A	A	A-K		

TABELLA MODELLI - ACCESSORI

MODELS - ACCESSORIES CHART

TIPI DI SCATOLE BOXES TYPE	VEGA AQUILA 62 82 102	VEGA FRECCIA 60	VEGA POLARIS 90 110	VEGA PULSAR 110 130 145	VEGA ALTAIR 160 200 240 290	VEGA AF 165	VEGA ADF 160 200 240 290
1.41	A	A	A	A	A-K		
1.42	A	A	A	A	A-K		
1.43	A	A	A	A	A-K		
1.44	A	A	A	A	A-K		
1.45	A	A	A	A	A-K		
1.46	A	A	A	A	A-K		
1.48	A-C	A-C	A-C	A-C	A-C		
1.49	A-C	A-C	A-C	A-C	A-C		
1.50	A-C	A-C	A-C	A-C	A-C		
2.01	A-B-C	A-B-C	A-B-C	A-B-C	A-C		
2.02	A-B-C	A-B-C	A-B-C	A-B-C	A-C		
2.03	A-B-C	A-B-C	A-B-C	A-B-C	A-C		
2.04	A-B-C	A-B-C	A-B-C	A-B-C	A-C		
2.05	A-B-C	A-B-C	A-B-C	A-B-C	A-C		
2.06	A-B-C	A-B-C	A-B-C	A-B-C	A-C		
2.07	A-B-C	A-B-C	A-B-C	A-B-C	A-C		
2.08	A-B-C	A-B-C	A-B-C	A-B-C	A-C		
2.09	A-B-C	A-B-C	A-B-C	A-B-C	A-C		
2.10	A-B-C	A-B-C	A-B-C	A-B-C	A-C		
2.11	A-B-C	A-B-C	A-B-C	A-B-C	A-C		

TIPI DI SCATOLE BOXES TYPE	VEGA AQUILA 62 82 102	VEGA FRECCIA 60	VEGA POLARIS 90 110	VEGA PULSAR 110 130 145	VEGA ALTAIR 160 200 240 290	VEGA AF 165	VEGA ADF 160 200 240 290
2.12	A-B-C	A-B-C	A-B-C	A-B-C	A-C		
2.13	A-B-C	A-B-C	A-B-C	A-B-C	A-C		
2.14	A-B-C	A-B-C	A-B-C	A-B-C	A-C		
2.15	A-B-C	A-B-C	A-B-C	A-B-C	A-C		
2.16	A-B-C	A-B-C	A-B-C	A-B-C	A-C		
2.17	A-B-C	A-B-C	A-B-C	A-B-C	A-C		
2.18	A-B-C	A-B-C	A-B-C	A-B-C	A-C		
2.19	A-B-C	A-B-C	A-B-C	A-B-C	A-C		
2.20	A-B-C	A-B-C	A-B-C	A-B-C	A-C		
2.21	A-B-C	A-B-C	A-B-C	A-B-C	A-C		
2.22	A-B-C	A-B-C	A-B-C	A-B-C	A-C		
2.23	A-B-C	A-B-C	A-B-C	A-B-C	A-C		
2.24	A-B-C	A-B-C	A-B-C	A-B-C	A-C		
2.26	A-B-C	A-B-C	A-B-C	A-B-C	A-C		
2.27	A-B-C	A-B-C	A-B-C	A-B-C	A-C		
3.01	A-B-C	A-B-C	A-B-C	A-B-C	A-C		
3.02	A-B-C	A-B-C	A-B-C	A-B-C	A-C		
3.03	A-B-C	A-B-C	A-B-C	A-B-C	A-C		
3.04	A-B-C	A-B-C	A-B-C	A-B-C	A-C		
3.05	A-B-C	A-B-C	A-B-C	A-B-C	A-C		

TABELLA MODELLI - ACCESSORI

MODELS - ACCESSORIES CHART

TIPI DI SCATOLE BOXES TYPE	VEGA AQUILA 62 82 102	VEGA FRECCIA 60	VEGA POLARIS 90 110	VEGA PULSAR 110 130 145	VEGA ALTAIR 160 200 240 290	VEGA AF 165	VEGA ADF 160 200 240 290
3.06	A-B-C	A-B-C	A-B-C	A-B-C	A-C		
3.07	A-B-C	A-B-C	A-B-C	A-B-C	A-C		
3.20	A-B-C-D	A-B-C-D	A-B-C-D	A-B-C-D	A-C		
3.21	A-B-C-D	A-B-C-D	A-B-C-D	A-B-C-D	A-C		
4.01	A-C	A-C	A-C	A-C	A-C		
4.02	A-B-F-G	A-B-F-G	A-B-F-G	A-B-F-G	A-Q-U		
4.03	A-B-F-G	A-B-F-G	A-B-F-G	A-B-F-G	A-Q-U		
4.04	A-B-F-G	A-B-F-G	A-B-F-G	A-B-F-G	-		
4.05	A-B-F-G	A-B-F-G	A-B-F-G	A-B-F-G	-		
4.06	A-B-F-G	A-B-F-G	A-B-F-G	A-B-F-G	-		
4.07	A-B-F-G	A-B-F-G	A-B-F-G	A-B-F-G	-		
4.08	A-B-F-G	A-B-F-G	A-B-F-G	A-B-F-G	-		
4.09	A-B-F-G	A-B-F-G	A-B-F-G	A-B-F-G	-		
4.10	A-B-F-G	A-B-F-G	A-B-F-G	A-B-F-G	-		
4.11	A-B-F-G	A-B-F-G	A-B-F-G	A-B-F-G	-		
5.01	A-B-F-H	A-B-F-H	A-B-F-H	A-B-F-H			
5.02	A-B-F-H	A-B-F-H	A-B-F-H	A-B-F-H			
5.03	A-B-F-H	A-B-F-H	A-B-F-H	A-B-F-H			
5.04	A-B-F-H	A-B-F-H	A-B-F-H	A-B-F-H			
5.05	A-B-F-H	A-B-F-H	A-B-F-H	A-B-F-H			

TIPI DI SCATOLE BOXES TYPE	VEGA AQUILA 62 82 102	VEGA FRECCIA 60	VEGA POLARIS 90 110	VEGA PULSAR 110 130 145	VEGA ALTAIR 160 200 240 290	VEGA AF 165	VEGA ADF 160 200 240 290
5.06	A-B-F-H-J	A-B-F-H-J	A-B-F-H-J	A-B-F-H-J			
5.15	A-B-C-H	A-B-C-H	A-B-C-H	A-B-C-H			
5.16	A-B-C-H	A-B-C-H	A-B-C-H	A-B-C-H			
5.20	A-B-F-H-I	A-B-F-H-I	A-B-F-H-I	A-B-F-H-I			
5.21	A-B-F-H-I	A-B-F-H-I	A-B-F-H-I	A-B-F-H-I			
5.22	A-B-F-H-I	A-B-F-H-I	A-B-F-H-I	A-B-F-H-I			
5.23	A-B-F-H	A-B-F-H	A-B-F-H	A-B-F-H			
5.24	A-B-F-H	A-B-F-H	A-B-F-H	A-B-F-H			
5.25	A-B-F-H	A-B-F-H	A-B-F-H	A-B-F-H			
5.26	A-B-F-H	A-B-F-H	A-B-F-H	A-B-F-H			
5.31	A-B-H-Q-W	A-B-H-Q-W	A-B-H-Q-W	A-B-H-Q-W			
5.32	A-B-H-Q-W	A-B-H-Q-W	A-B-H-Q-W	A-B-H-Q-W			
5.33	A-B-H-Q-W	A-B-H-Q-W	A-B-H-Q-W	A-B-H-Q-W			
6.01	A-B-F-L	A-B-F-L	A-B-F-L	A-B-F-L			
6.02	A-B-F-L	A-B-F-L	A-B-F-L	A-B-F-L			
6.03	A-B-F-L	A-B-F-L	A-B-F-L	A-B-F-L			
6.04	A-B-F-L	A-B-F-L	A-B-F-L	A-B-F-L			
6.05	A-B-F-L	A-B-F-L	A-B-F-L	A-B-F-L			
6.06	A-B-F-L	A-B-F-L	A-B-F-L	A-B-F-L			
6.07	A-B-F-L	A-B-F-L	A-B-F-L	A-B-F-L			

TABELLA MODELLI - ACCESSORI

MODELS - ACCESSORIES CHART

TIPI DI SCATOLE BOXES TYPE	VEGA AQUILA 62 82 102	VEGA FRECCIA 60	VEGA POLARIS 90 110	VEGA PULSAR 110 130 145	VEGA ALTAIR 160 200 240 290	VEGA AF 165	VEGA ADF 160 200 240 290
7.01	A-B-F-L	A-B-F-L	A-B-F-L	A-B-F-L			
7.02	A-B-F-L	A-B-F-L	A-B-F-L	A-B-F-L			
7.03	A-B-F-L	A-B-F-L	A-B-F-L	A-B-F-L			
7.04	A-B-F-L	A-B-F-L	A-B-F-L	A-B-F-L			
8.01	A-B-F-M	A-B-F-M	A-B-F-M	A-B-F-M			
8.02	A-B-F-M	A-B-F-M	A-B-F-M	A-B-F-M			
9.01	A-B-C-N	A-B-C-N	A-B-C-N	A-B-C-N	A-C-N		
9.02	A-B-C-N-O	A-B-C-N-O	A-B-C-N-O	A-B-C-N	A-C-N		
9.03	A-B-C-N	A-B-C-N	A-B-C-N	A-B-C-N	A-C-N		
9.04	A-B-C-N	A-B-C-N	A-B-C-N	A-B-C-N	A-C-N		
9.05	A-B-C-N-O	A-B-C-N-O	A-B-C-N-O	A-B-C-N	A-C-N		
9.06	A-B-C-N	A-B-C-N	A-B-C-N	A-B-C-N	A-C-N		
9.07	A-B-C-N	A-B-C-N	A-B-C-N	A-B-C-N	A-C-N		
9.08	A-B-C-N	A-B-C-N	A-B-C-N	A-B-C-N	A-C-N		
9.09	A-B-C-N	A-B-C-N	A-B-C-N	A-B-C-N	A-C-N		
9.10	A-B-C-N-O	A-B-C-N-O	A-B-C-N-O	A-B-C-N	A-C-N		
9.11	A-B-C-N	A-B-C-N	A-B-C-N	A-B-C-N	A-C-N		
9.12	A-B-C-N	A-B-C-N	A-B-C-N	A-B-C-N	A-C-N		
9.13	A-B-C-N-O	A-B-C-N-O	A-B-C-N-O	A-B-C-N	A-C-N		
9.14	A-B-C-N-O	A-B-C-N-O	A-B-C-N-O	A-B-C-N	A-C-N		

TIPI DI SCATOLE BOXES TYPE	VEGA AQUILA 62 82 102	VEGA FRECCIA 60	VEGA POLARIS 90 110	VEGA PULSAR 110 130 145	VEGA ALTAIR 160 200 240 290	VEGA AF 165	VEGA ADF 160 200 240 290
9.20	A-B-C-N-O	A-B-C-N-O	A-B-C-N-O	A-B-C-N-O	A-C-N-O		
9.21	A-B-C-N-O	A-B-C-N-O	A-B-C-N-O	A-B-C-N-O	A-C-N-O		
9.22	A-B-C-N-O	A-B-C-N-O	A-B-C-N-O	A-B-C-N-O	A-C-N-O		
9.23	A-B-C-N-O	A-B-C-N-O	A-B-C-N-O	A-B-C-N-O	A-C-N-O		
9.24	A-B-C-N-O	A-B-C-N-O	A-B-C-N-O	A-B-C-N-O	A-C-N-O		
9.25	A-B-C-N-O	A-B-C-N-O	A-B-C-N-O	A-B-C-N-O	A-C-N-O		
9.26	A-B-C-N-O	A-B-C-N-O	A-B-C-N-O	A-B-C-N-O	A-C-N-O		
9.27	A-B-C-N-O	A-B-C-N-O	A-B-C-N-O	A-B-C-N-O	A-C-N-O		
9.28	A-B-C-N-O	A-B-C-N-O	A-B-C-N-O	A-B-C-N-O	A-C-N-O		
9.30	A-B-C-N	A-B-C-N	A-B-C-N	A-B-C-N	A-C-N		
9.40	A-B-C-V	A-B-C-V	A-B-C-V	A-B-C-V	A-C-V		
9.41	A-B-C-f-G-N	A-B-C-f-G-N	A-B-C-f-G-N	A-B-C-f-G-N	A-C-U		
9.42	A-B-C-N-S	A-B-C-N-S	A-B-C-N-S	A-B-C-N-S	A-C-S-T		
10.01	A-B-G-S-Q	A-B-G-S-Q	A-B-G-S-Q	A-B-G-S-Q			
10.02	A-B-G-S-Q	A-B-G-S-Q	A-B-G-S-Q	A-B-G-S-Q			
10.10	A-B-G-S-Q	A-B-G-S-Q	A-B-G-S-Q	A-B-G-S-Q			
10.11	A-B-G-S-Q	A-B-G-S-Q	A-B-G-S-Q	A-B-G-S-Q			
10.12	A-B-G-S-Q	A-B-G-S-Q	A-B-G-S-Q	A-B-G-S-Q			
10.13	A-B-G-S-Q	A-B-G-S-Q	A-B-G-S-Q	A-B-G-S-Q			
10.14	A-B-G-S-Q	A-B-G-S-Q	A-B-G-S-Q	A-B-G-S-Q			

TABELLA MODELLI - ACCESSORI

MODELS - ACCESSORIES CHART

TIPI DI SCATOLE BOXES TYPE	VEGA	VEGA	VEGA	VEGA	VEGA	VEGA	VEGA
	AQUILA 62 82 102	FRECCIA 60	POLARIS 90 110	PULSAR 110 130 145	ALTAIR 160 200 240 290	AF 165	ADF 160 200 240 290
10.15	A-B-G-S-Q	A-B-G-S-Q	A-B-G-S-Q	A-B-G-S-Q			
10.16	A-B-G-S-Q	A-B-G-S-Q	A-B-G-S-Q	A-B-G-S-Q			
10.17	A-B-G-S-Q	A-B-G-S-Q	A-B-G-S-Q	A-B-G-S-Q			
10.18	A-B-G-S-Q	A-B-G-S-Q	A-B-G-S-Q	A-B-G-S-Q			
10.19	A-B-G-S-Q	A-B-G-S-Q	A-B-G-S-Q	A-B-G-S-Q			
10.20	A-B-G-S-Q	A-B-G-S-Q	A-B-G-S-Q	A-B-G-S-Q			
10.21	A-C	A-C	A-C	A-C	A-C		
10.22	A-C	A-C	A-C	A-C	A-C		
10.23	A-B-G-S-Q	A-B-G-S-Q	A-B-G-S-Q	A-B-G-S-Q			
10.24	A-B-G-S-Q	A-B-G-S-Q	A-B-G-S-Q	A-B-G-S-Q			
10.25	A-B-G-S-Q	A-B-G-S-Q	A-B-G-S-Q	A-B-G-S-Q			
10.26	A-C-S	A-C-S	A-C-S	A-C-S			
10.27	A-B-C-P	A-B-C-P	A-B-C-P	A-B-C-P			
10.28	A-B-C-P	A-B-C-P	A-B-C-P	A-B-C-P			
10.29	A-B-C-D-R	A-B-C-D-R	A-B-C-D-R	A-B-C-D-R	A-C		

TIPI DI SCATOLE BOXES TYPE	VEGA	VEGA	VEGA	VEGA	VEGA	VEGA	VEGA
	AQUILA 62 82 102	FRECCIA 60	POLARIS 90 110	PULSAR 110 130 145	ALTAIR 160 200 240 290	AF 165	ADF 160 200 240 290
10.30	A-B-C-R	A-B-C-R	A-B-C-R	A-B-C-R	A-C		
10.31	A-B-C-R	A-B-C-R	A-B-C-R	A-B-C-R	A-C		
10.32						A-Q	A-Q
10.33						A-Q	A-Q
10.34						A-Q	A-Q
10.35						A-Q-S	A-Q-S
10.36						-	A-Q-S
10.37						-	A-Q-S
10.38						-	A-Q-S
10.41	A-B-C-P-N-S	A-B-C-P-N-S	A-B-C-P-N-S	A-B-C-P-N-S			
10.42	A-B-C-P-N-S	A-B-C-P-N-S	A-B-C-P-N-S	A-B-C-P-N-S			
10.43	A-B-N-Q-S	A-B-N-Q-S	A-B-N-Q-S	A-B-N-Q-S			
10.44	A-B-Q	A-B-Q	A-B-Q	A-B-Q	A-C		
10.45	A-B-H-N-Q-S	A-B-H-N-Q-S	A-B-H-N-Q-S	A-B-H-N-Q-S			
10.46	A-B-C-N-O	A-B-C-N-O	A-B-C-N-O	A-B-C-N-O			

1

SCATOLE PIEGHEVOLI CON INCOLLATURA LONGITUDINALE NORMALE

STRAIGHT-LINE FOLDING CARTONS

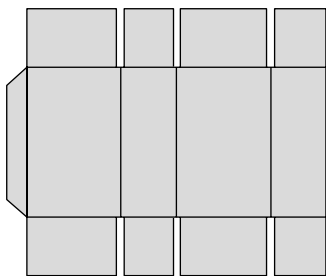
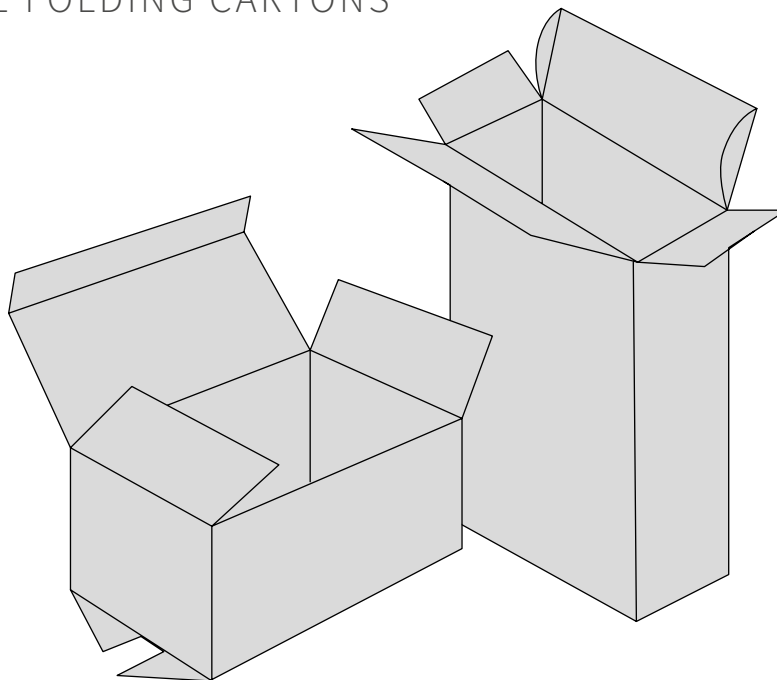

1.01

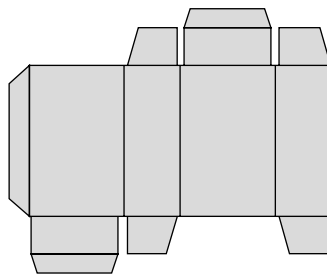

1.02

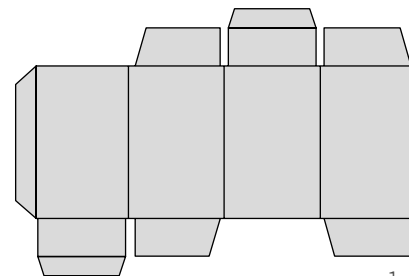

1.03

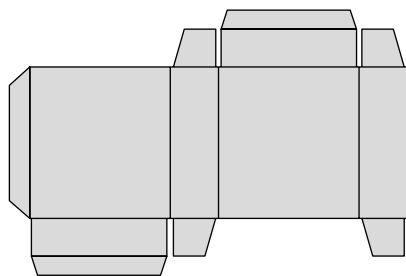

1.04

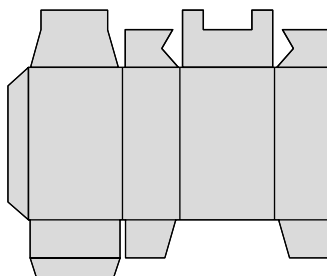

1.05

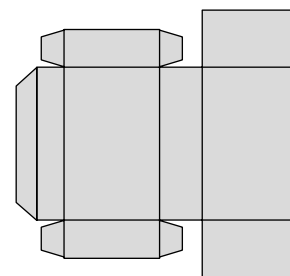

1.06

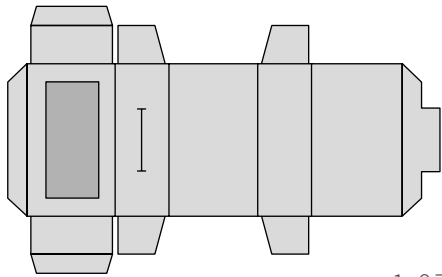

1.07

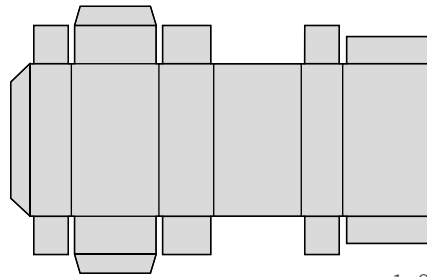

1.08

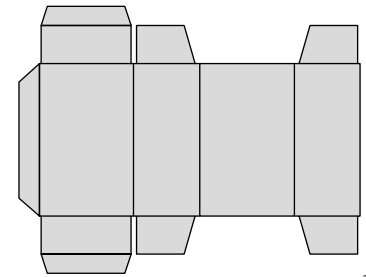

1.09

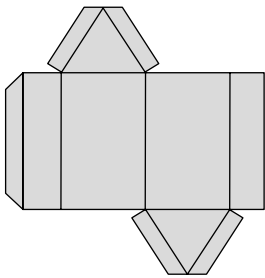

1.10

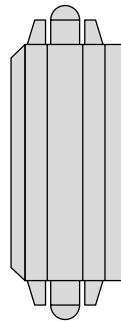

1.11

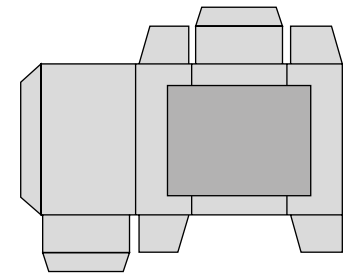

1.12

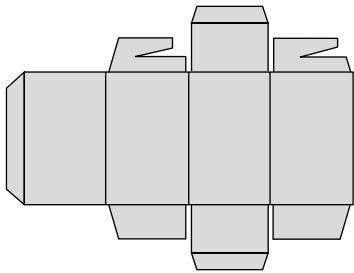

1.13

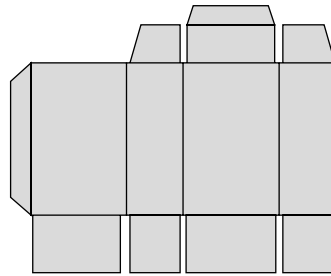

1.14

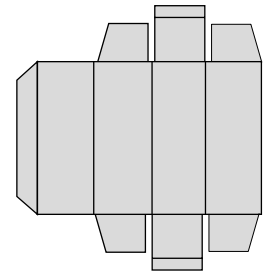

1.15

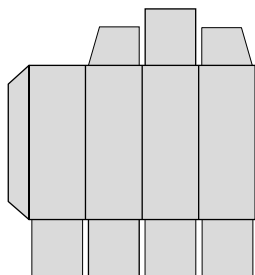

1.16

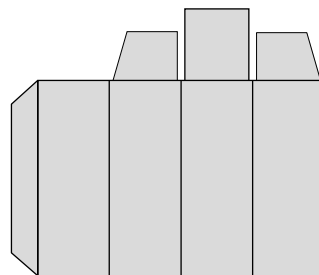

1.17

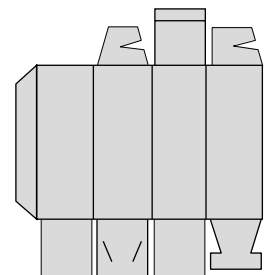

1.18

1

SCATOLE PIEGHEVOLI CON INCOLLATURA LONGITUDINALE NORMALE

STRAIGHT-LINE FOLDING CARTONS

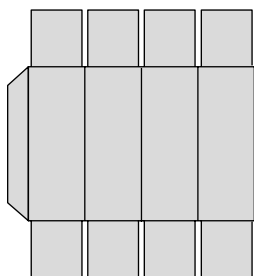

1.19

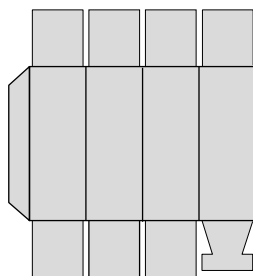

1.20

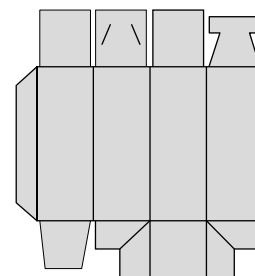

1.21

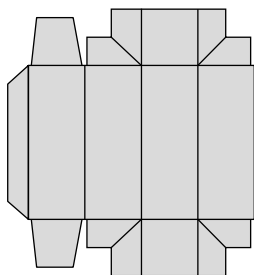

1.22

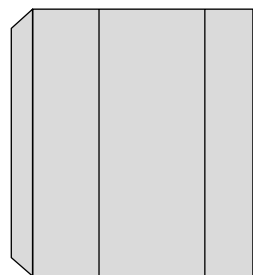

1.23

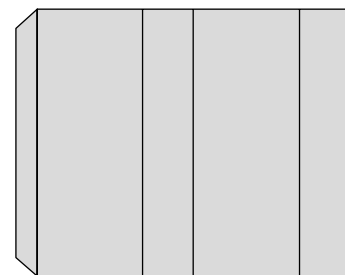

1.24

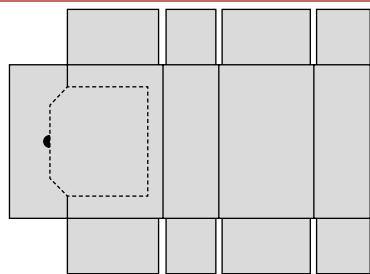

1.25

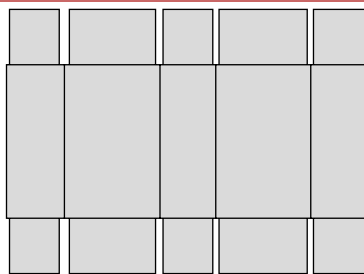

1.26

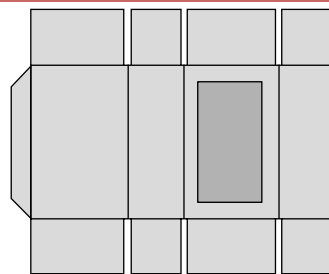

1.27

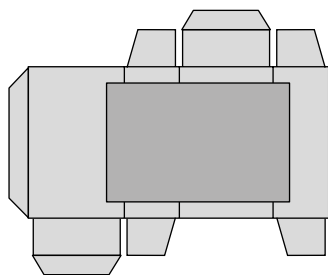

1.28

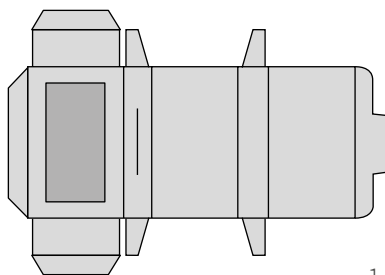

1.29

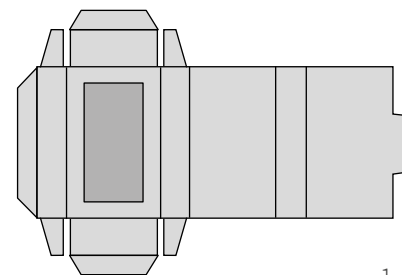

1.30

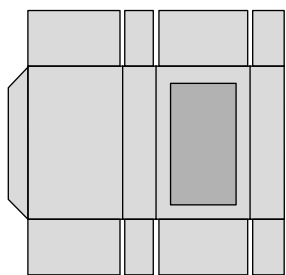

1.31

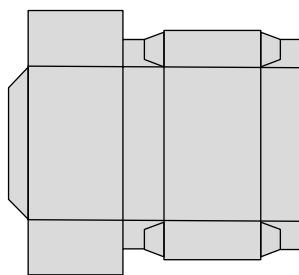

1.32

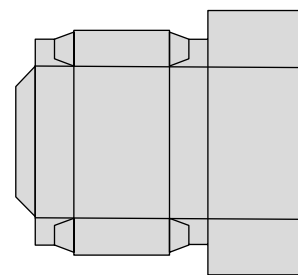

1.33

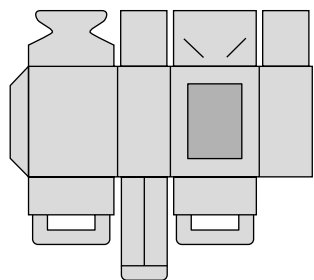

1.34

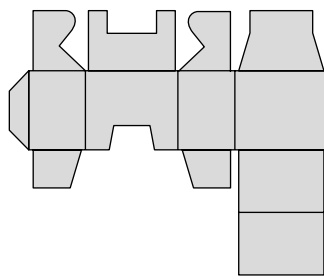

1.35

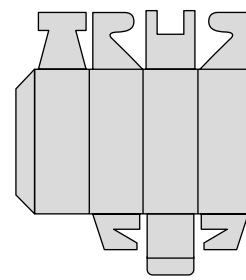

1.36

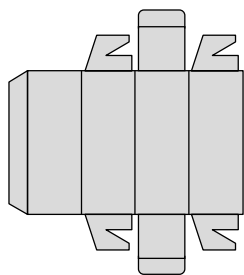

1.37

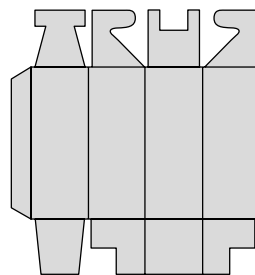

1.38

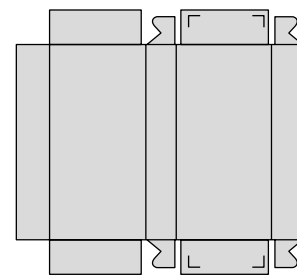

1.39

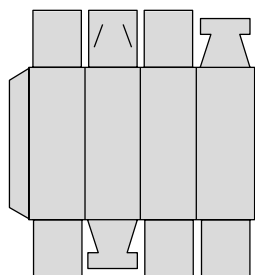

1.40

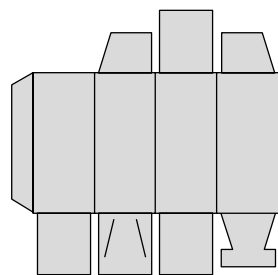

1.41

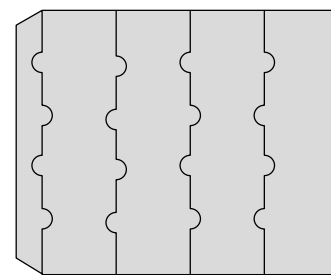

1.42

1

SCATOLE PIEGHEVOLI CON INCOLLATURA LONGITUDINALE NORMALE

STRAIGHT-LINE FOLDING CARTONS

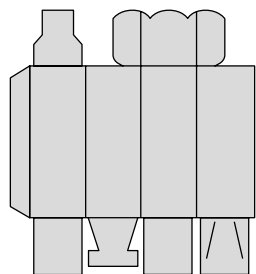

1.43

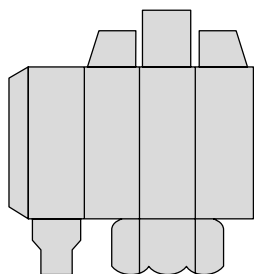

1.44

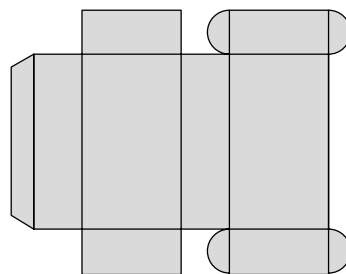

1.45

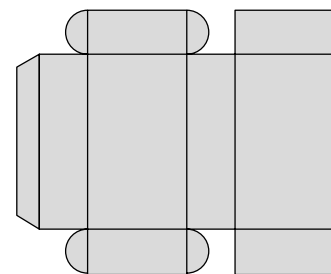

1.46

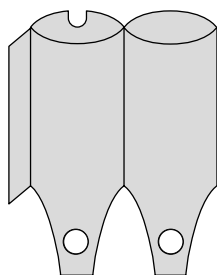

1.48

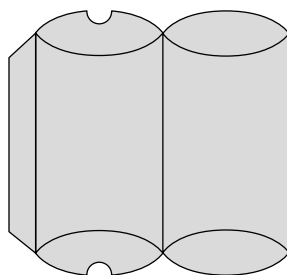

1.49

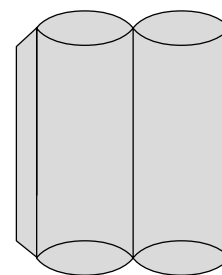

1.50

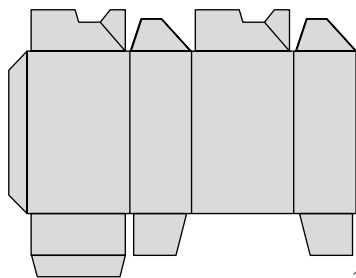
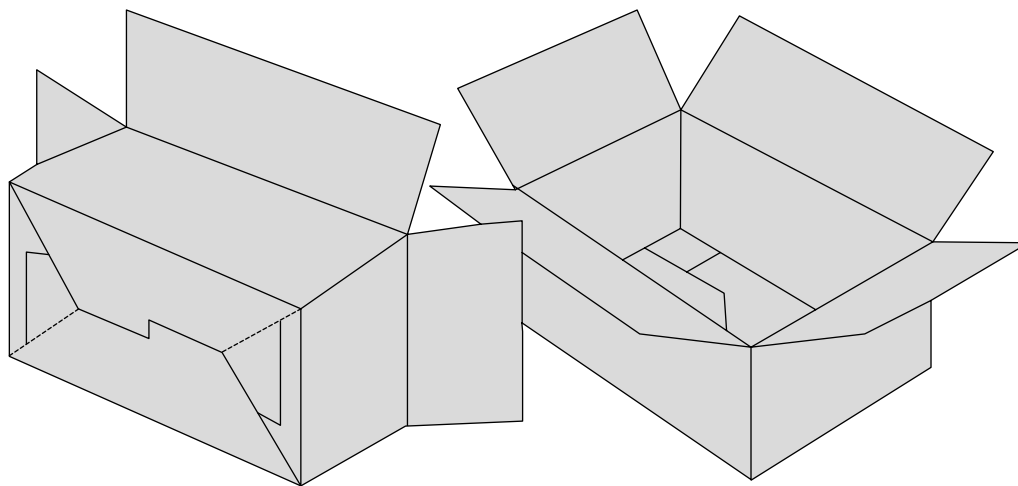

2.01

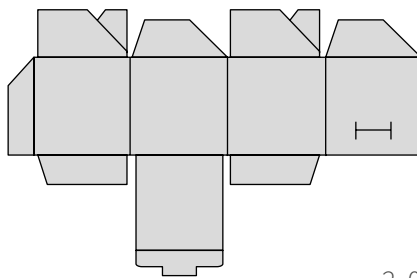

2.02

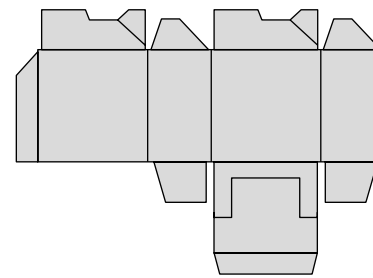

2.03

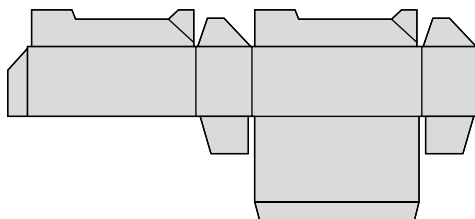

2.04

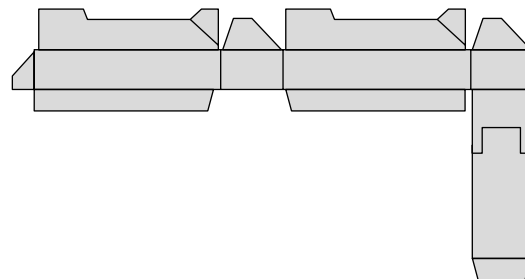

2.05

2 SCATOLE CON FONDO A CHIUSURA AUTOMATICA

CRASH LOCK BOTTOM CARTONS

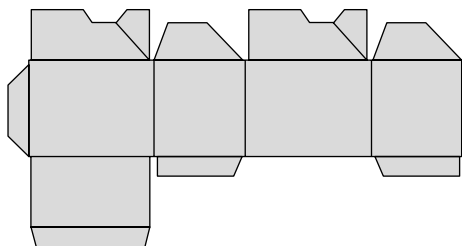

2.06

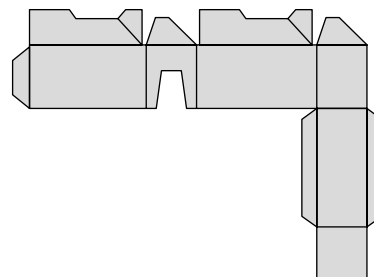

2.07

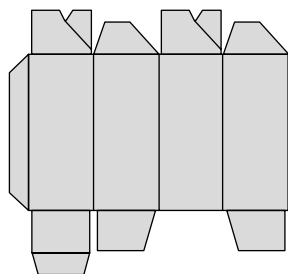

2.08

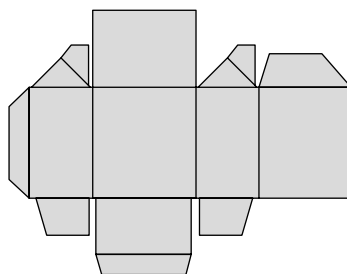

2.09

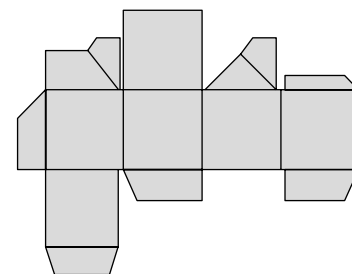

2.10

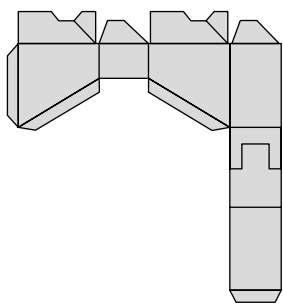

2.11

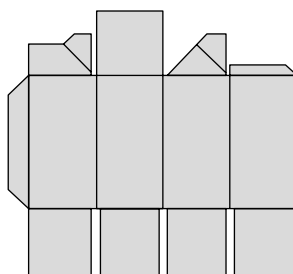

2.12

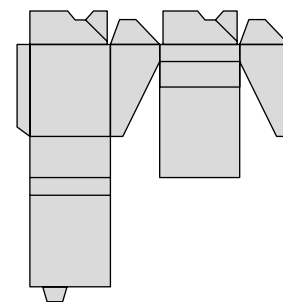

2.13

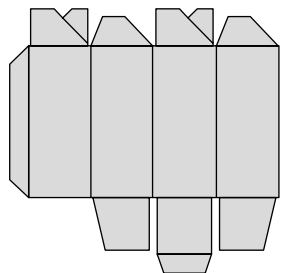

2.14

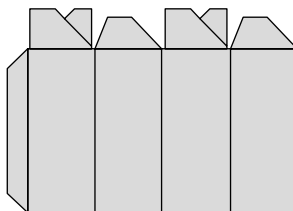

2.15

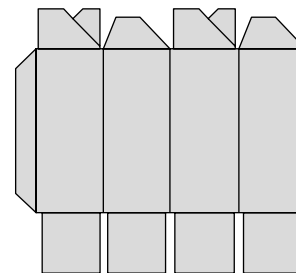

2.16

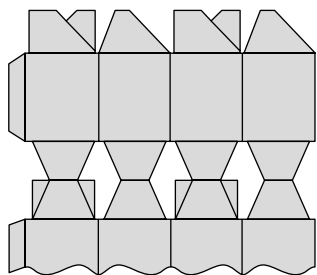

2.17

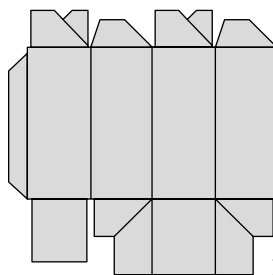

2.18

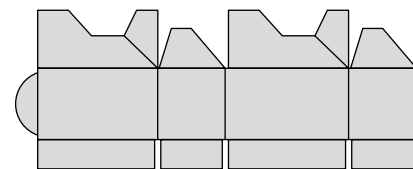

2.19

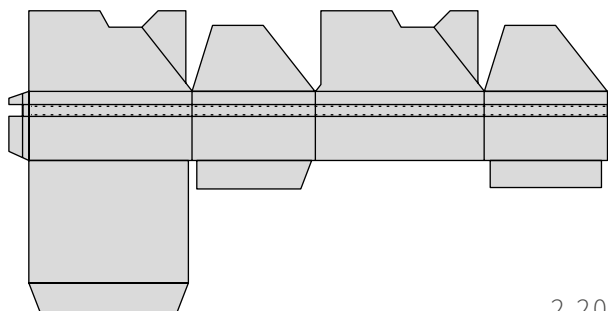

2.20

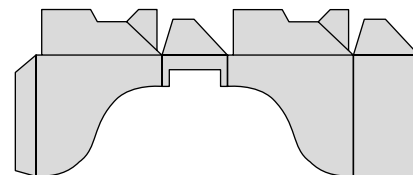

2.21

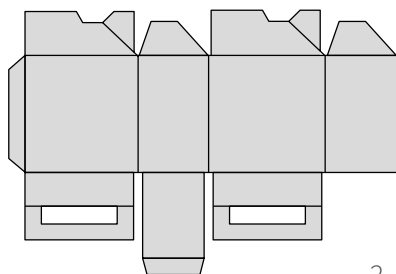

2.22

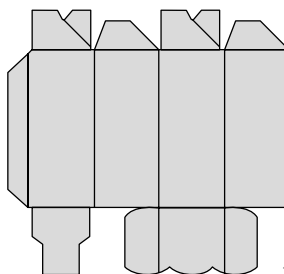

2.23

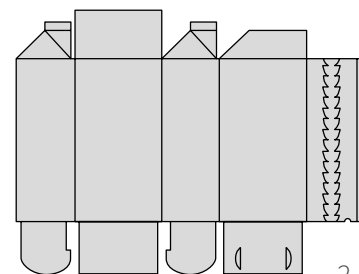

2.24

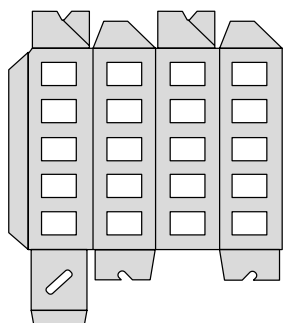

2.26

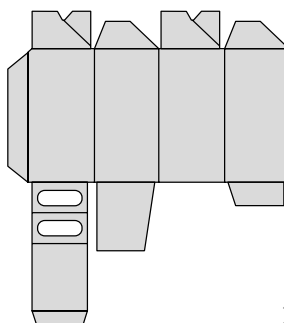

2.27

3

SCATOLE PIEGHEVOLI CON FONDO A CHIUSURA AUTOMATICA SPECIALE

SPECIAL LOCK BOTTOM CARTONS

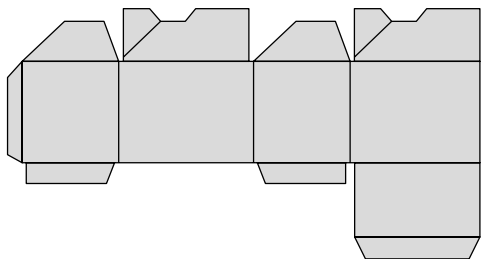

3.01

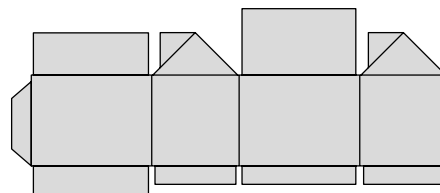

3.02

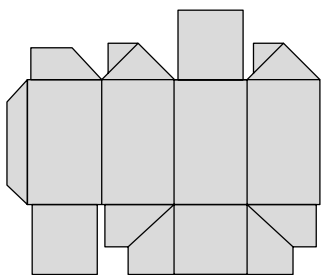

3.03

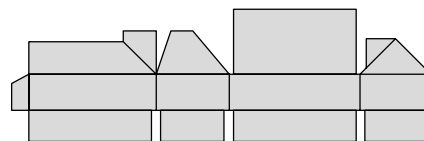

3.04

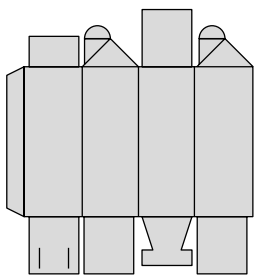

3.05

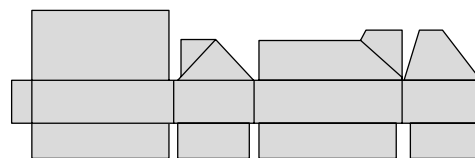

3.06

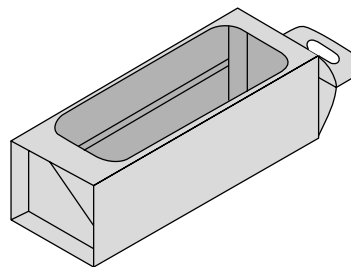
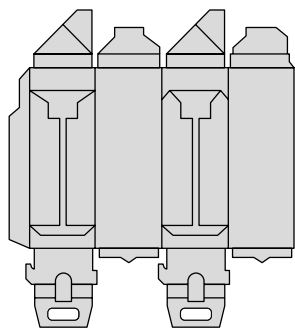

3.07

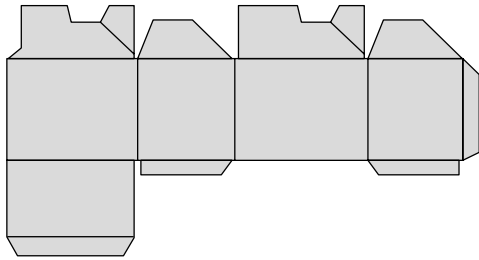

3.20

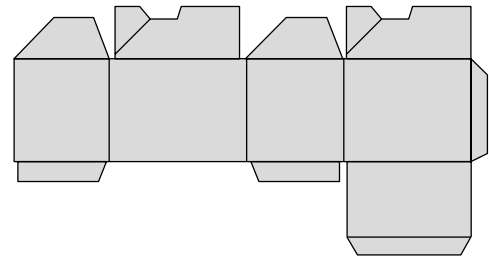

3.21

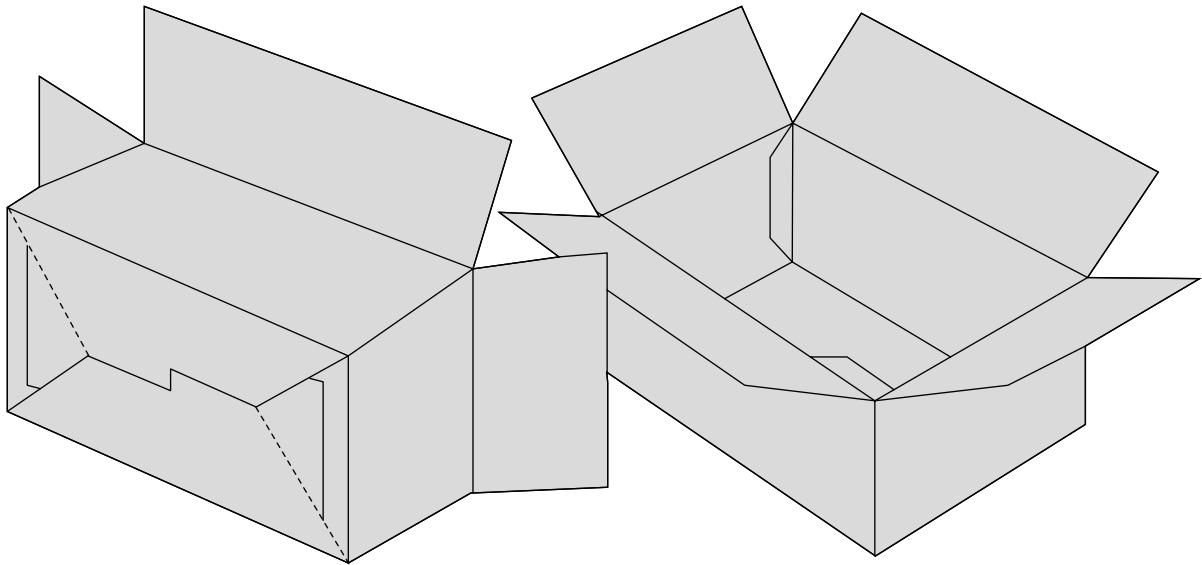

4

SCATOLE CON PARETE SEMPLICE E DOPPIA PARETE

DOUBLE WALL, COMPOUND-FOLD DOUBLE WALL CARTONS

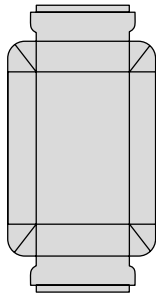
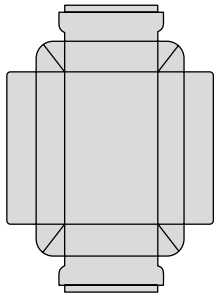

4.01

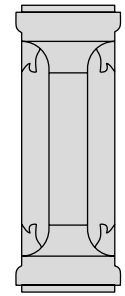
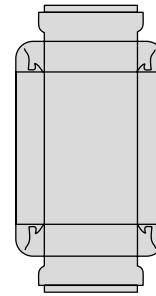
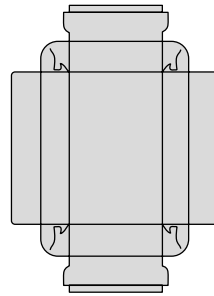

4.02

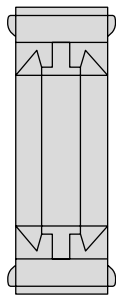
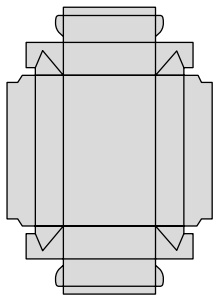

4.03

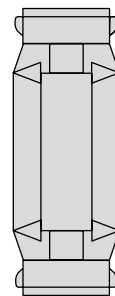
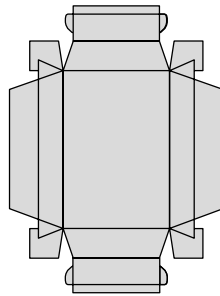

4.04

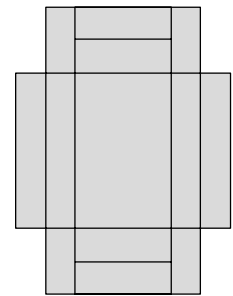

4.05

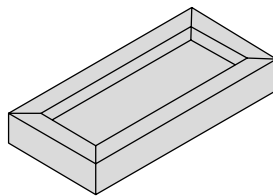
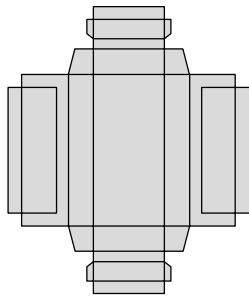

4.06

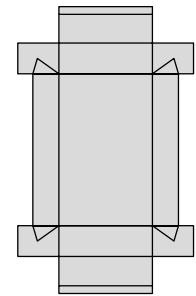

4.07

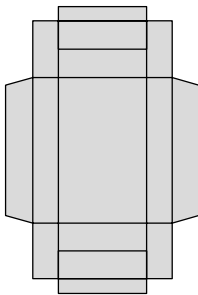

4.08

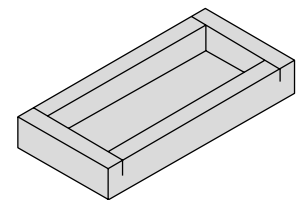
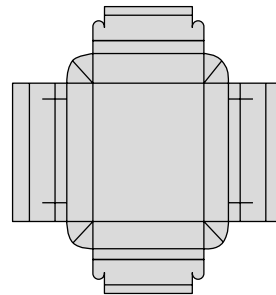

4.09

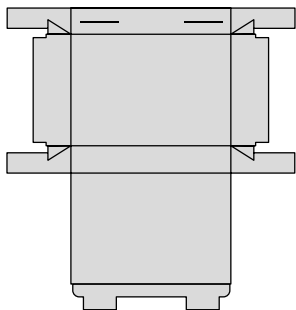

4.10

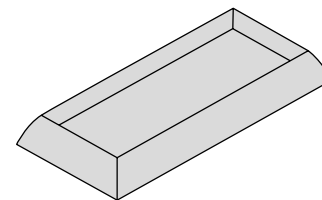
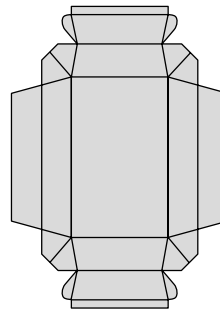

4.11

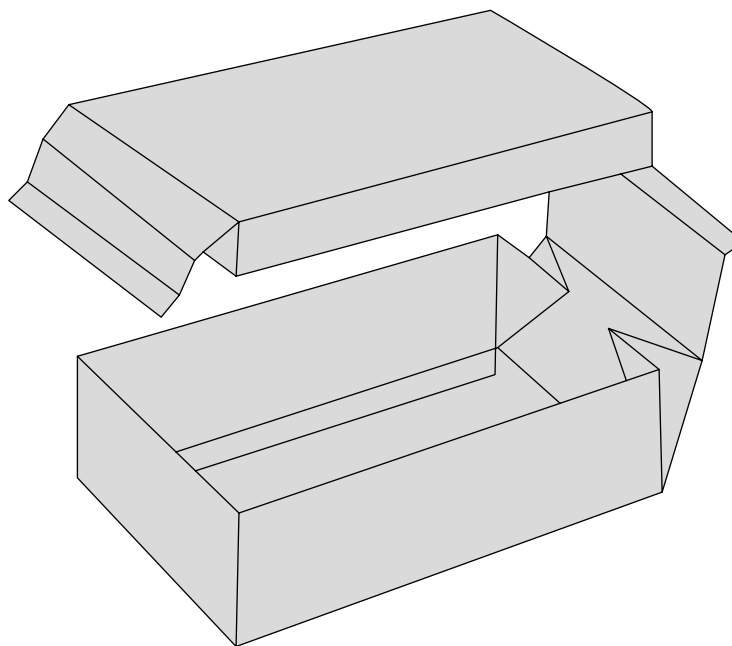

5

BUSTE DA SPEDIZIONE E PER DISCHI

MAILING ENVELOPES AND RECORD COVERS

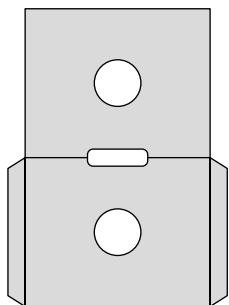

5.01

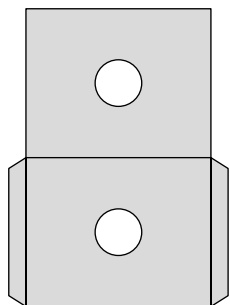

5.02

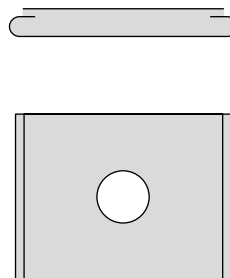

5.03

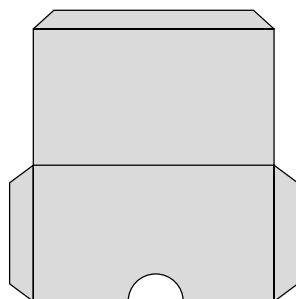

5.04

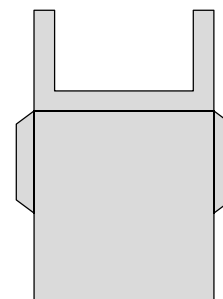

5.05

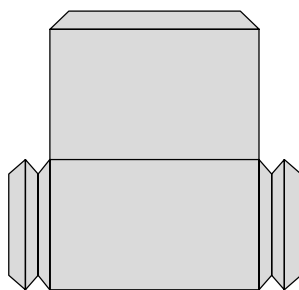

5.06

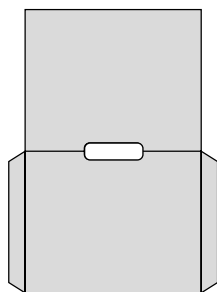

5.15

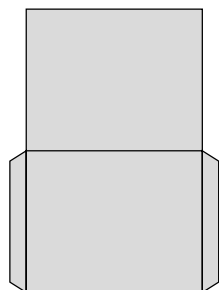

5.16

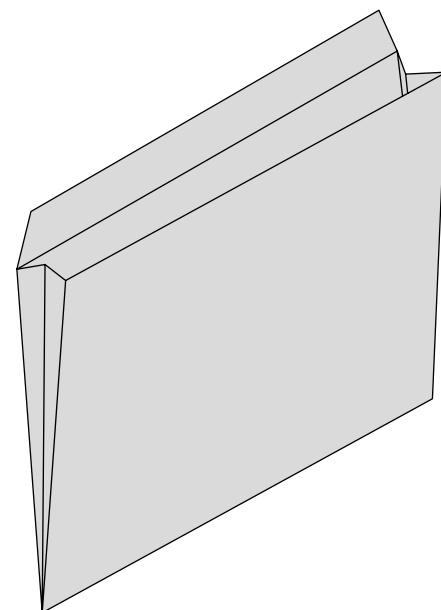
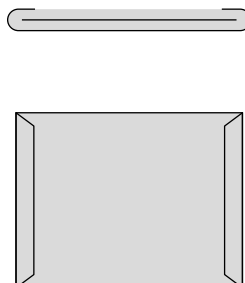

BUSTE DA SPEDIZIONE E PER DISCHI

MAILING ENVELOPES AND RECORD COVERS

5

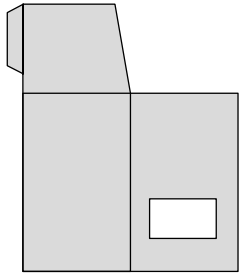

5.20

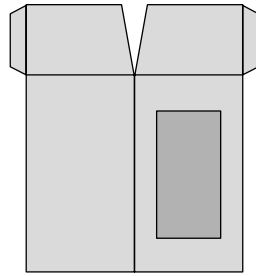

5.21

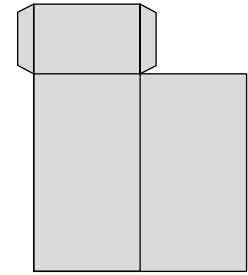

5.22

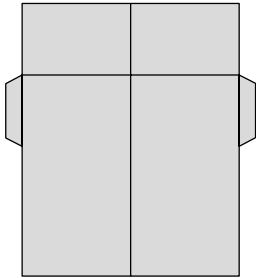

5.23

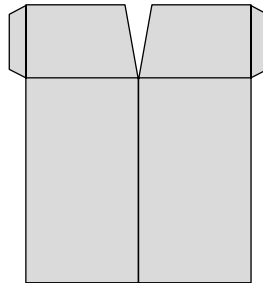

5.24

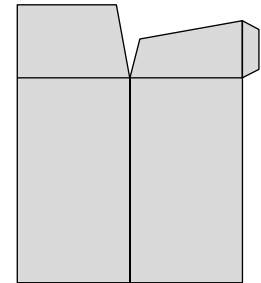

5.25

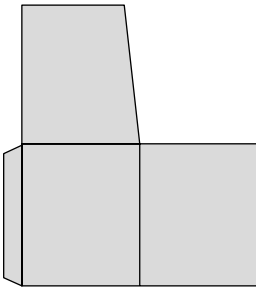

5.26

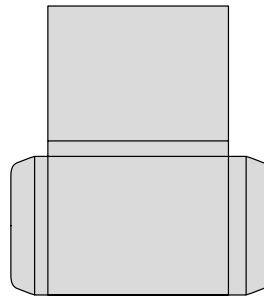

5.31

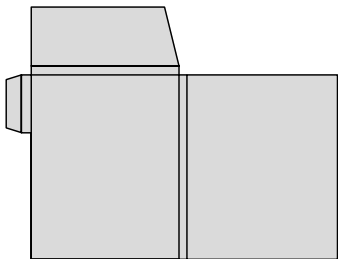
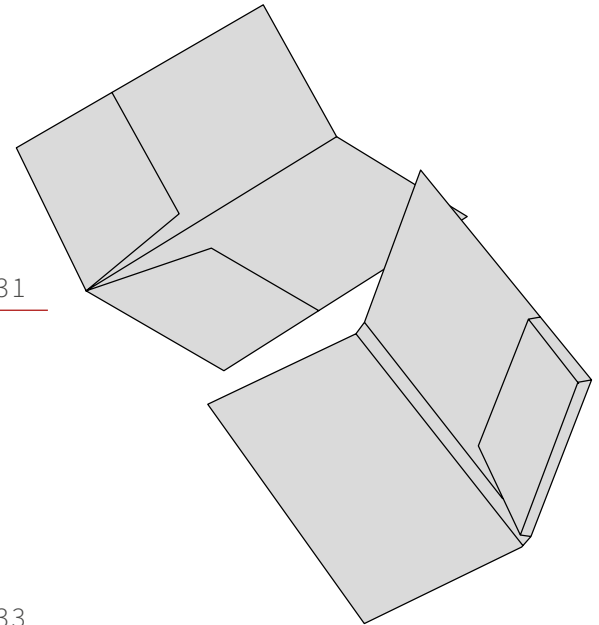

5.32

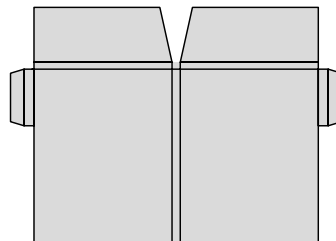

5.33

6

SCATOLE PIEGHEVOLI CONICHE

TAPERED CARTONS

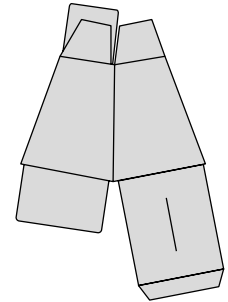
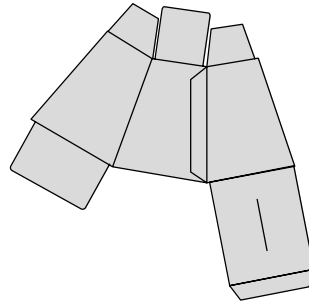
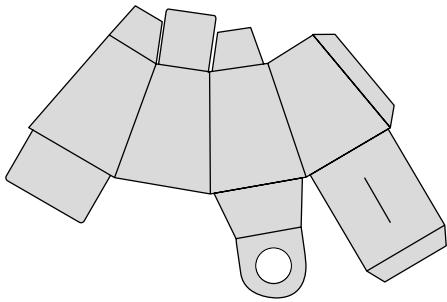

6.01

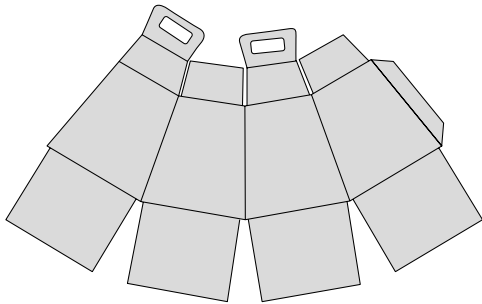

6.02

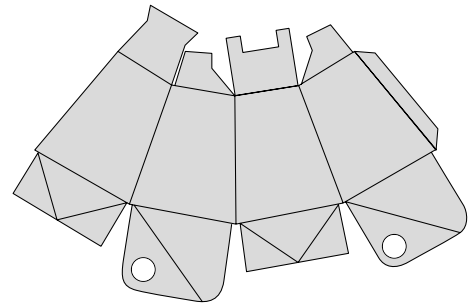

6.03

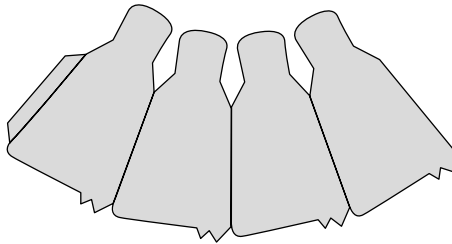

6.04

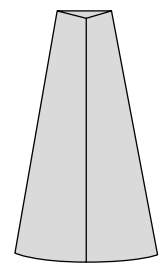
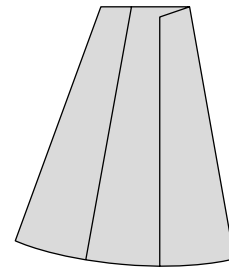
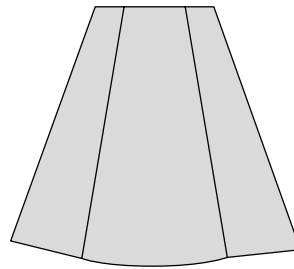

6.05

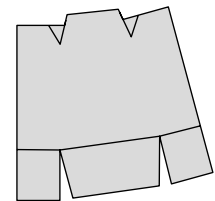
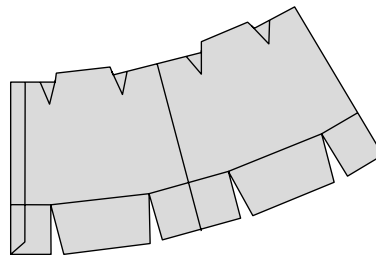
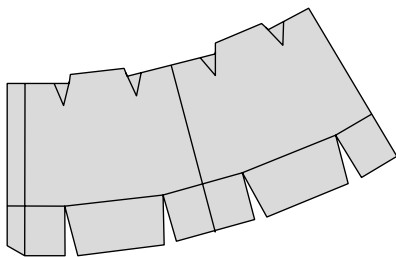

6.06

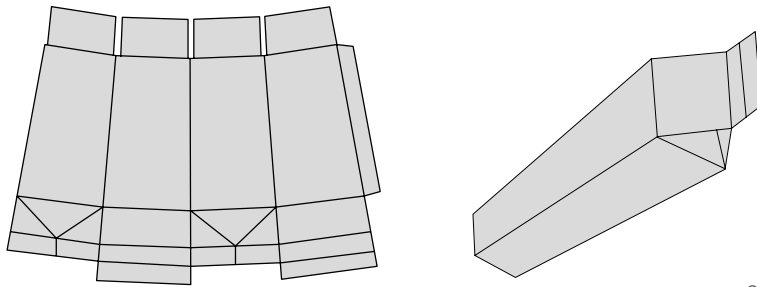

6.07

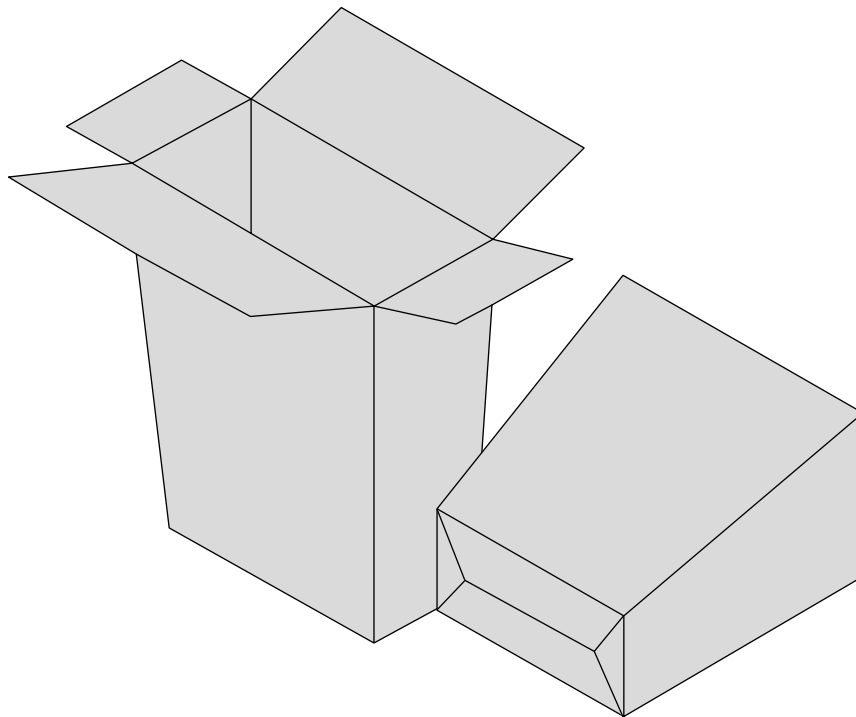

7 SCATOLE PIEGHEVOLI CONICHE CON FONDO A CHIUSURA AUTOMATICA

TAPERED CARTONS WITH CRASH LOCK BOTTOM

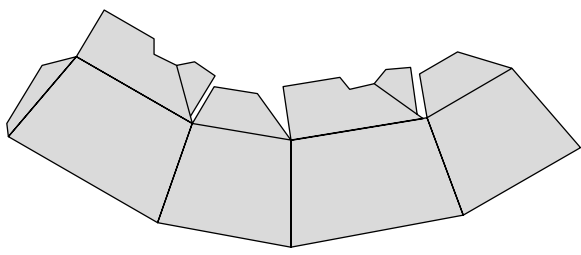

7.01

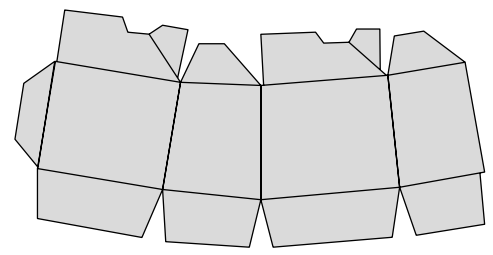

7.02

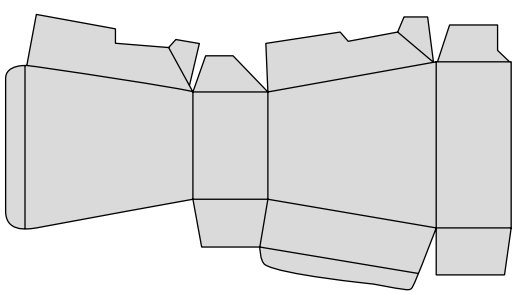

7.03

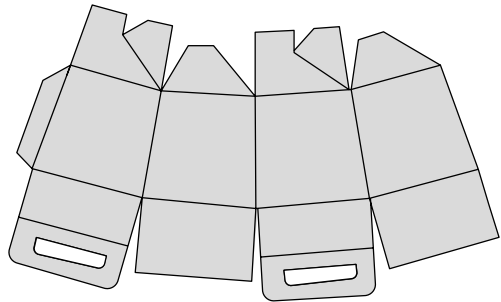

7.04

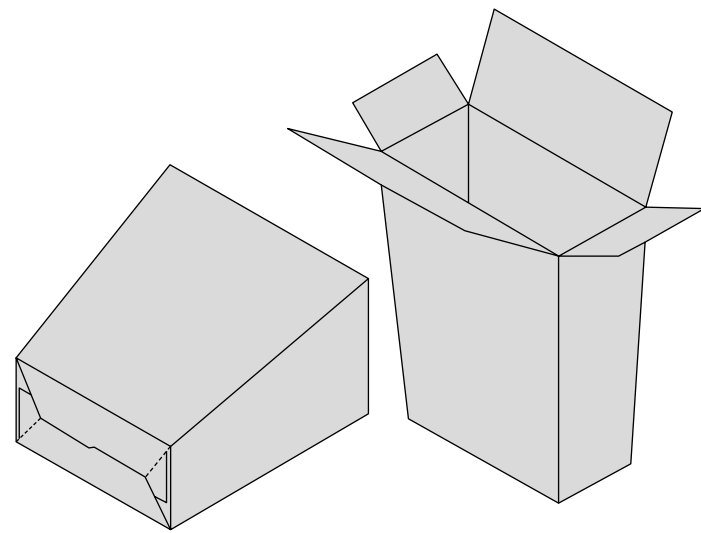

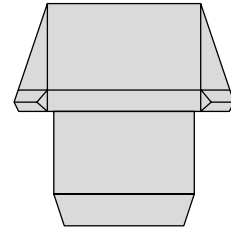
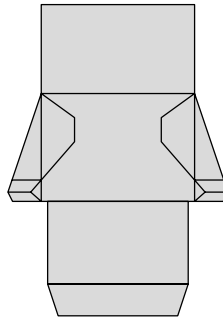
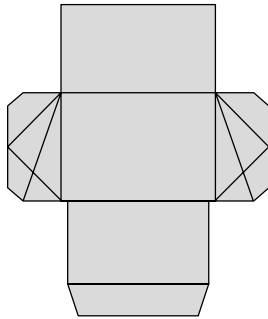

8.01

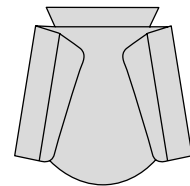
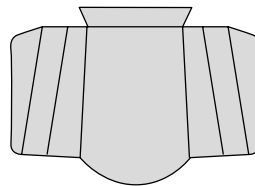
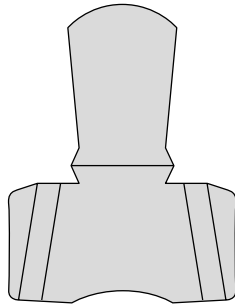

8.02

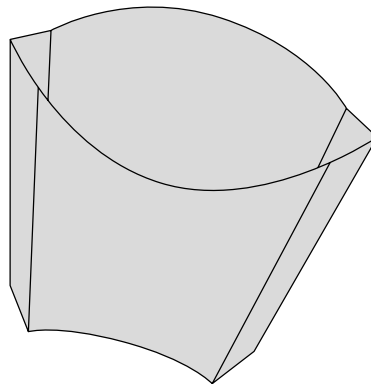

9

SCATOLE A 4 OPPURE A 6 INCOLLATURE

4 CORNERS WITH LID, 6 CORNERS COLLAPSIBLE BOX

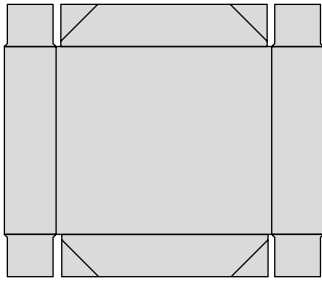
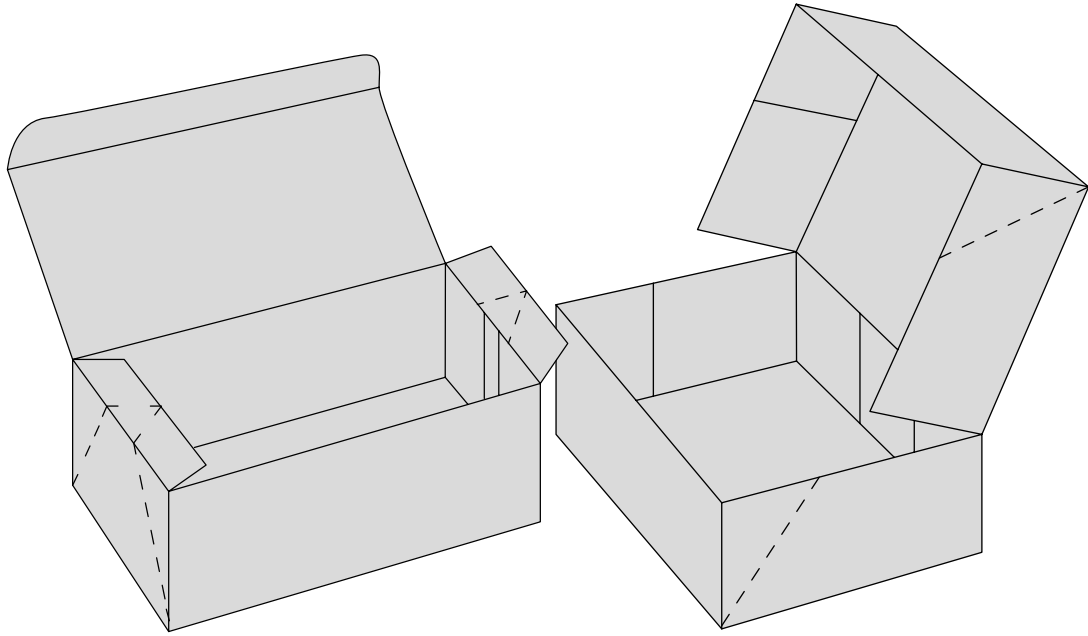

9.01

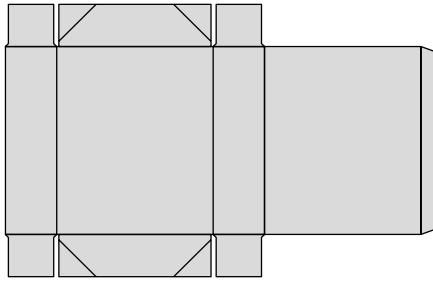

9.02

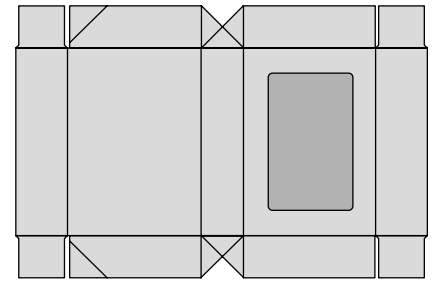

9.03

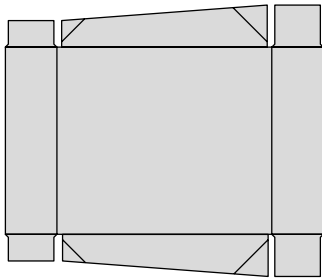

9.04

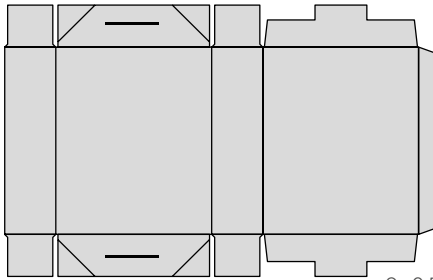

9.05

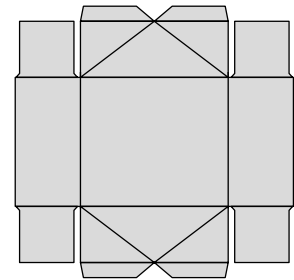

9.06

4 CORNERS WITH LID, 6 CORNERS COLLAPSIBLE BOX

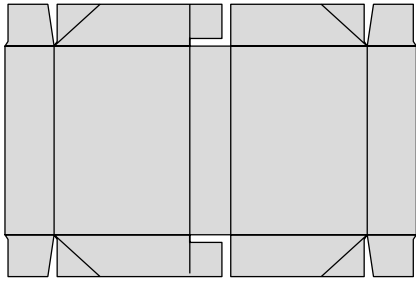

9.07



9.08

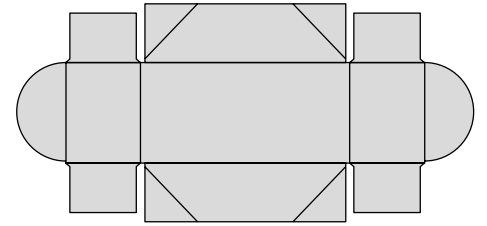

9.09

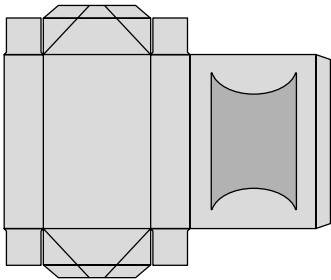

9.10

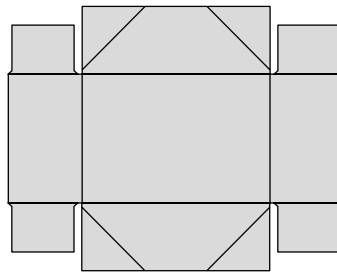

9.11

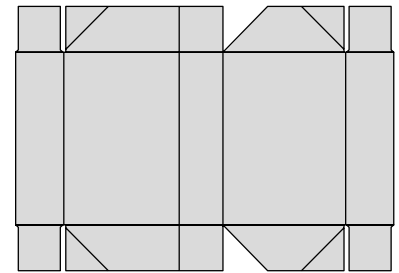

9.12

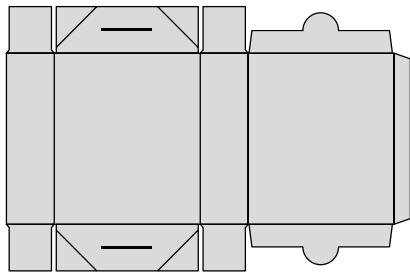

9.13

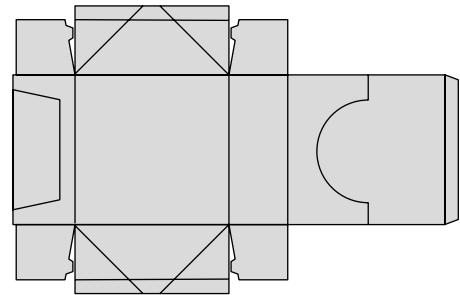

9.14

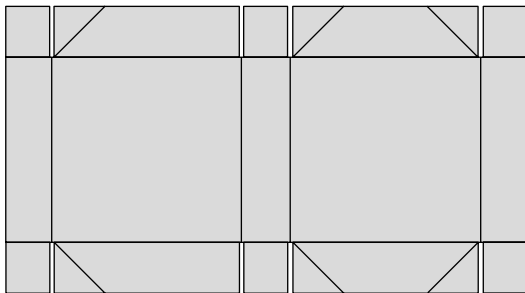

9.20

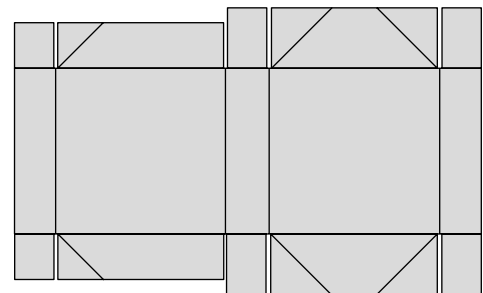

9.21

9

SCATOLE A 4 OPPURE A 6 INCOLLATURE

4 CORNERS WITH LID, 6 CORNERS COLLAPSIBLE BOX

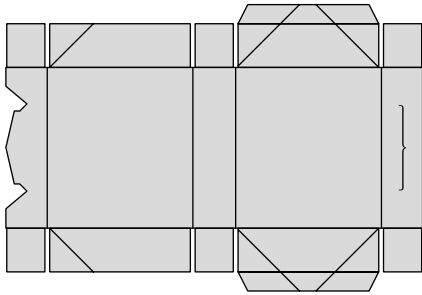

9.22

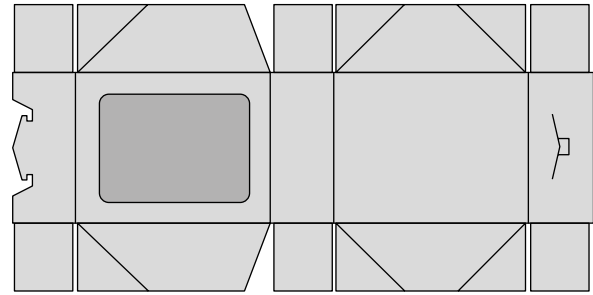

9.23

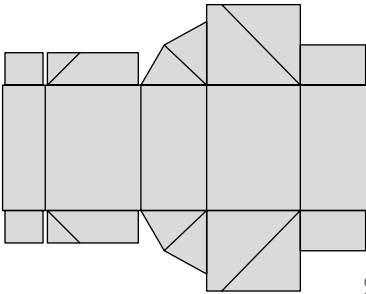

9.24

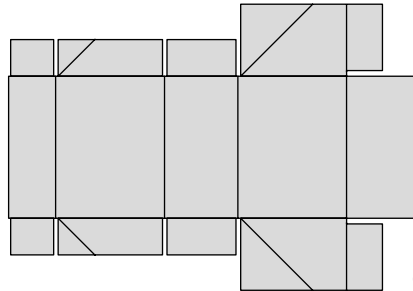

9.25

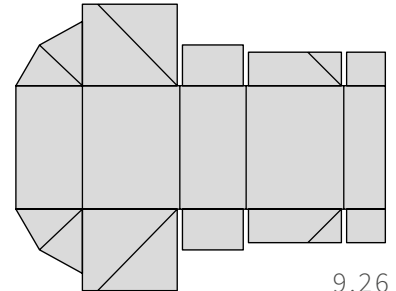

9.26

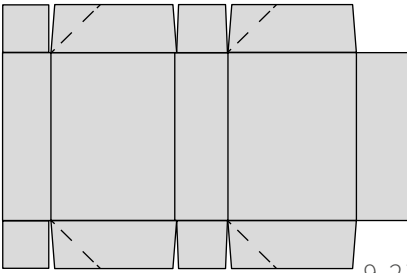

9.27

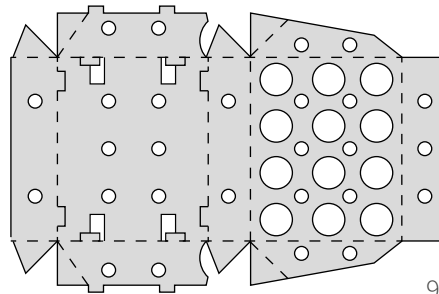

9.28

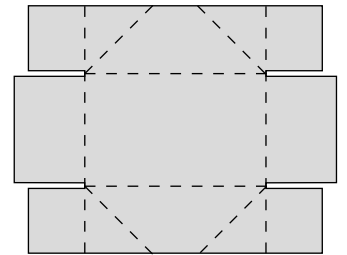

9.30

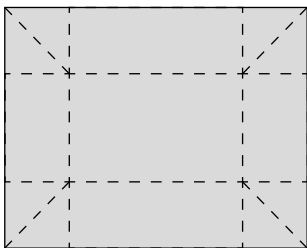

9.40

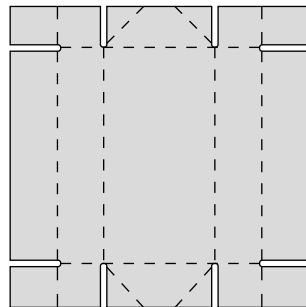

9.41

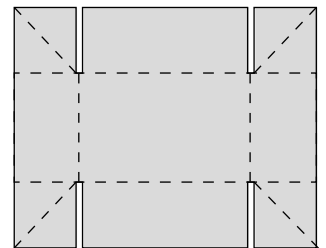

9.42

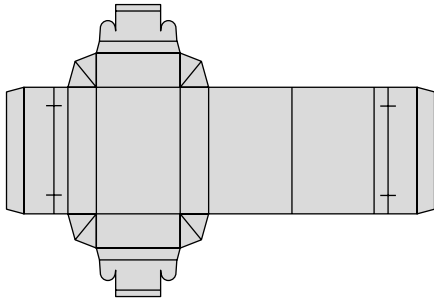

10.01

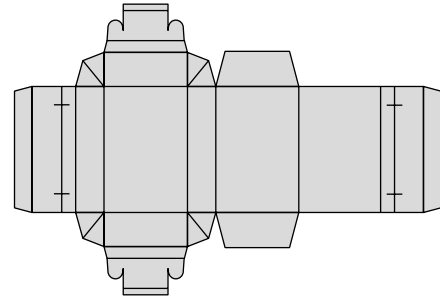

10.02

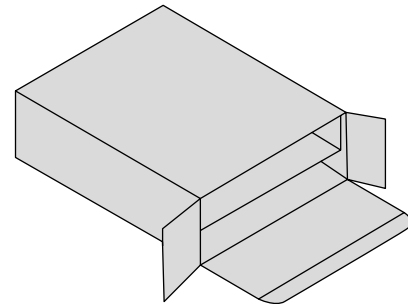
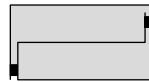
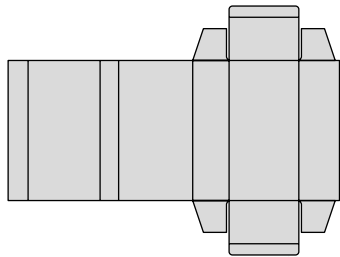

10.10

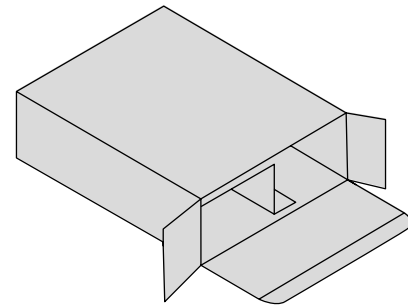
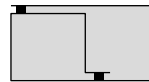
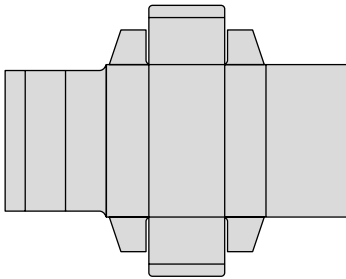

10.11

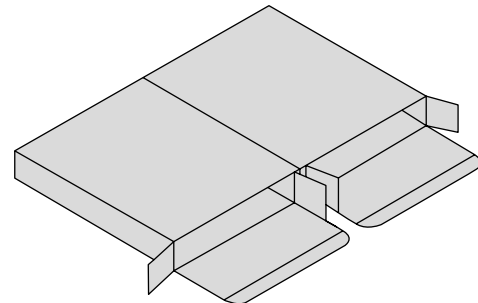
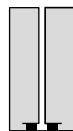
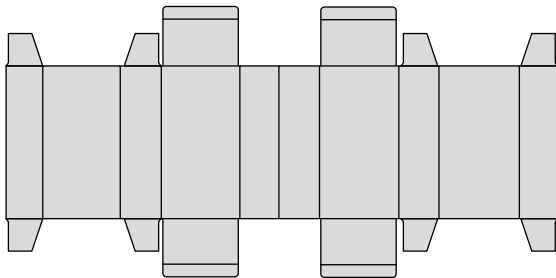

10.12

10

SCATOLE SPECIALI, INVIO CAMPIONI INDISPENSABILE

SPECIAL CARTONS, PLEASE SUBMIT SAMPLES

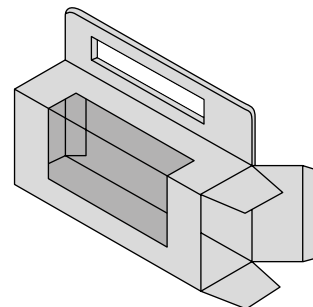
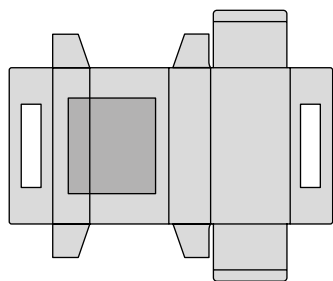

10.13

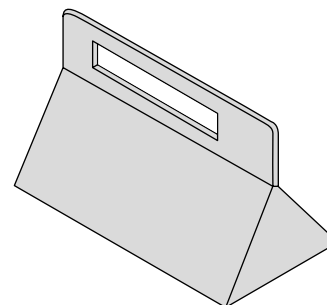
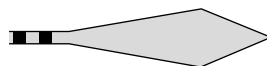
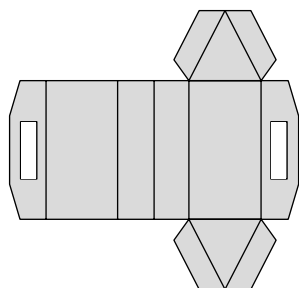

10.14

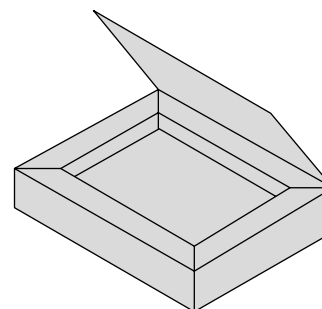
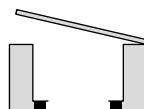
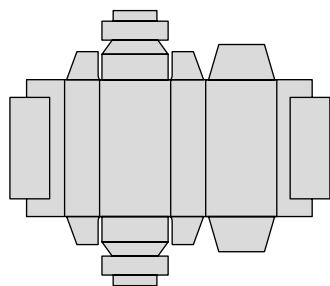

10.15

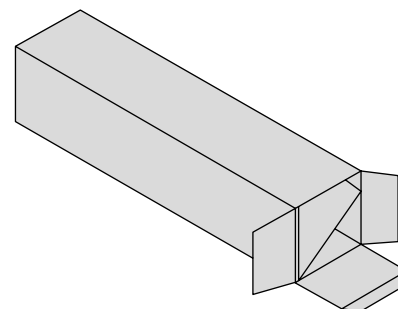
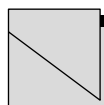
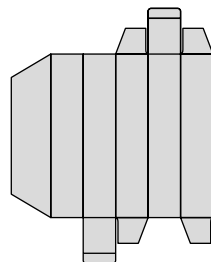

10.16

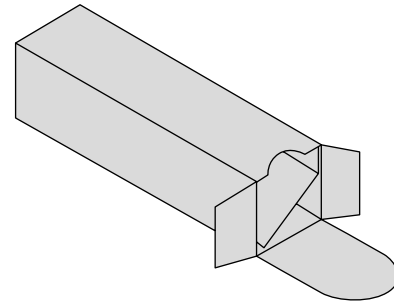
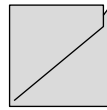
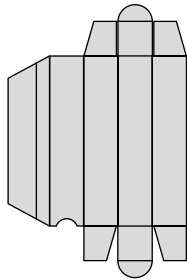

10.17

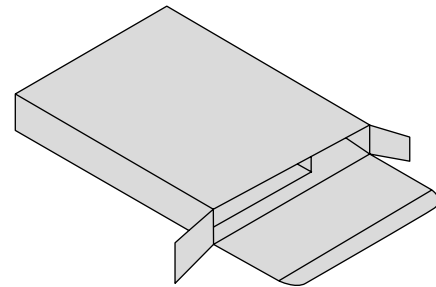
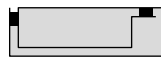
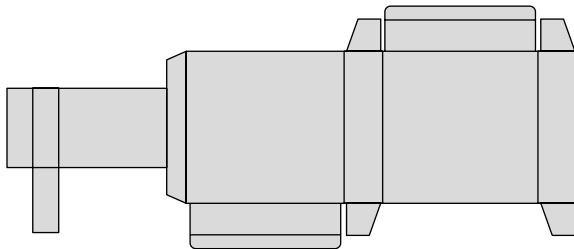

10.18

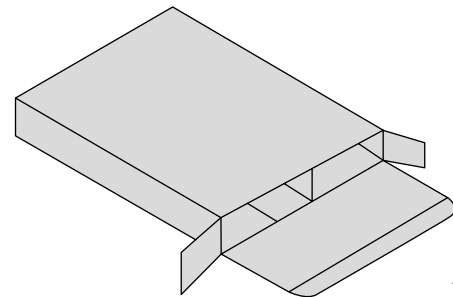
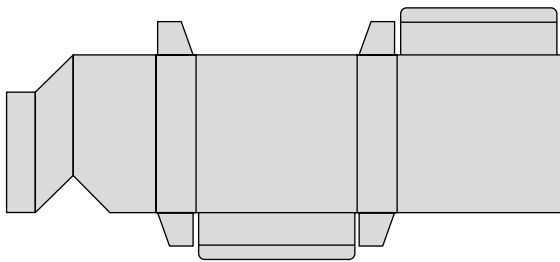

10.19

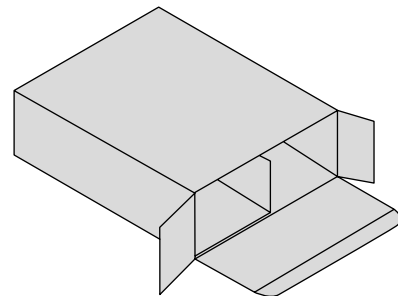
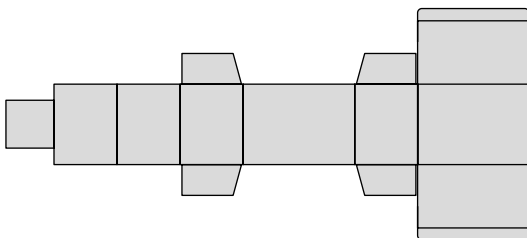

10.20

10

SCATOLE SPECIALI, INVIO CAMPIONI INDISPENSABILE

SPECIAL CARTONS, PLEASE SUBMIT SAMPLES

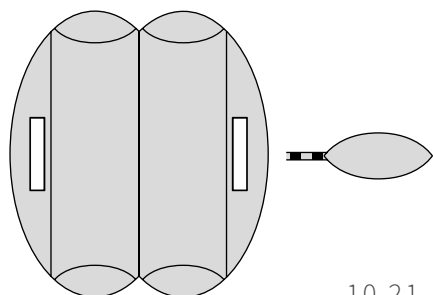

10.21

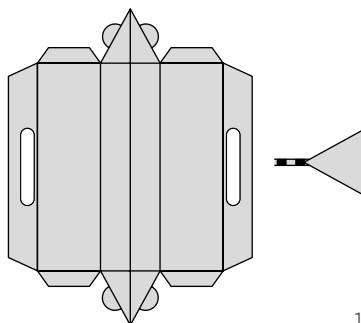

10.22

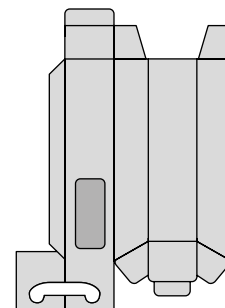

10.23

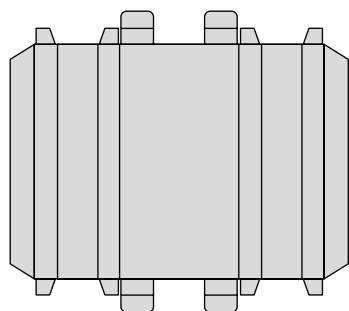

10.24

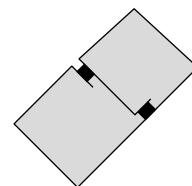
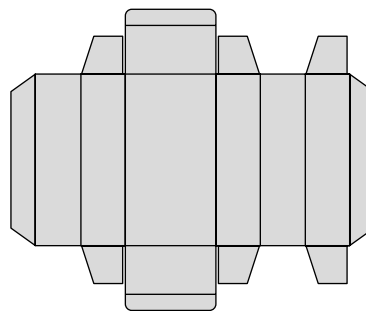

10.25

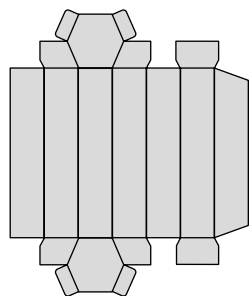

10.26

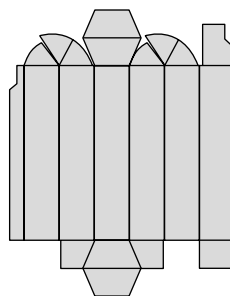

10.27

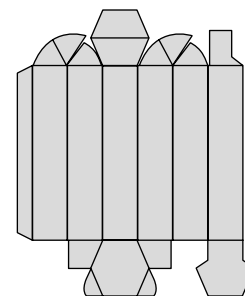

10.28

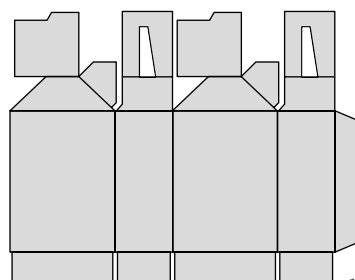

10.29

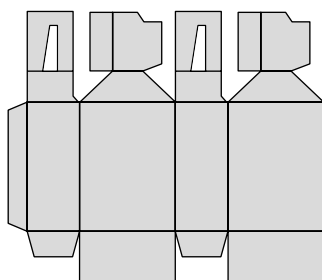

10.30

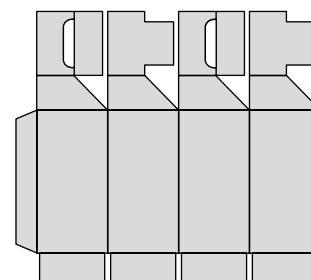

10.31

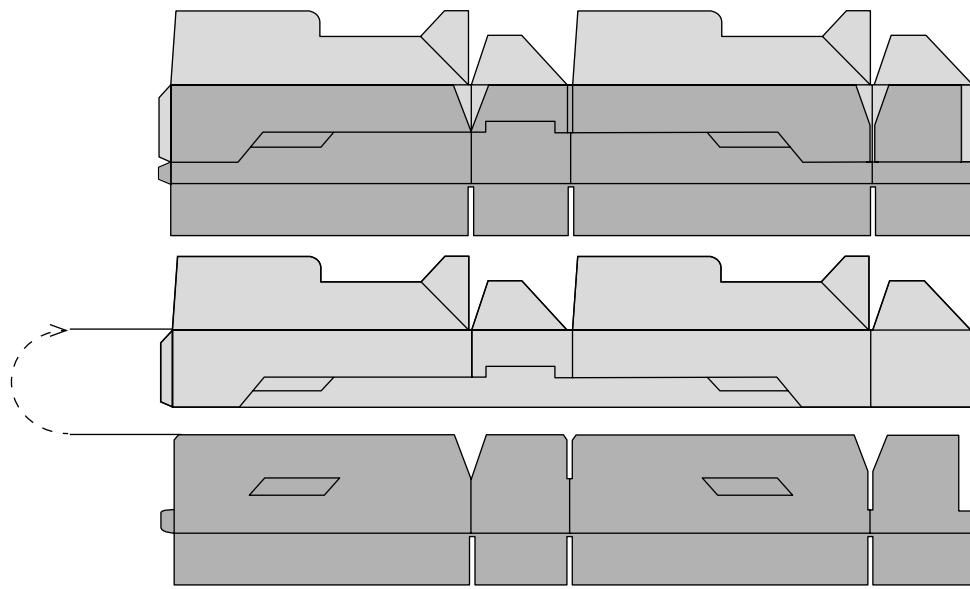

10.32

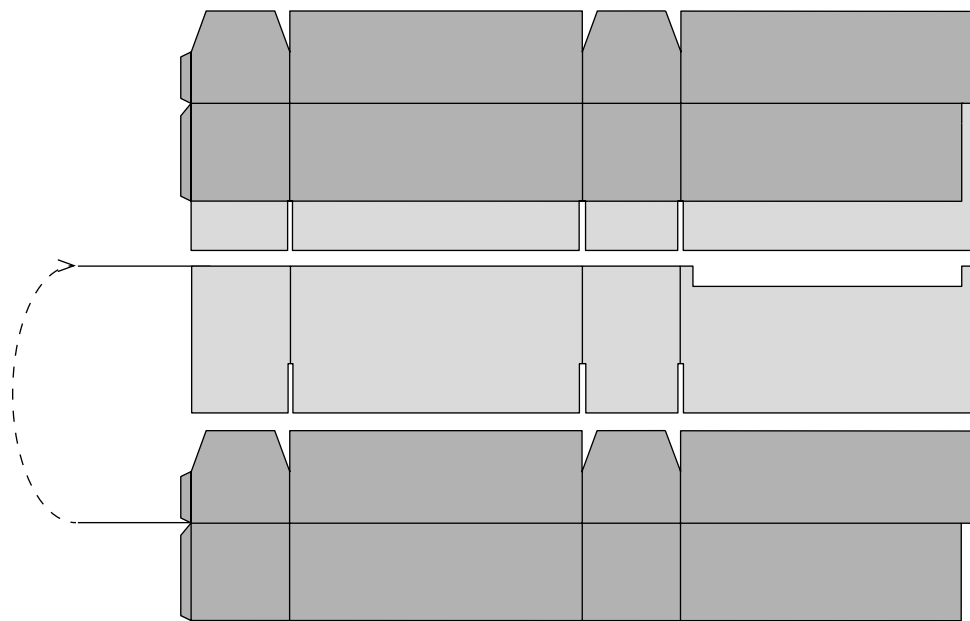

10.33

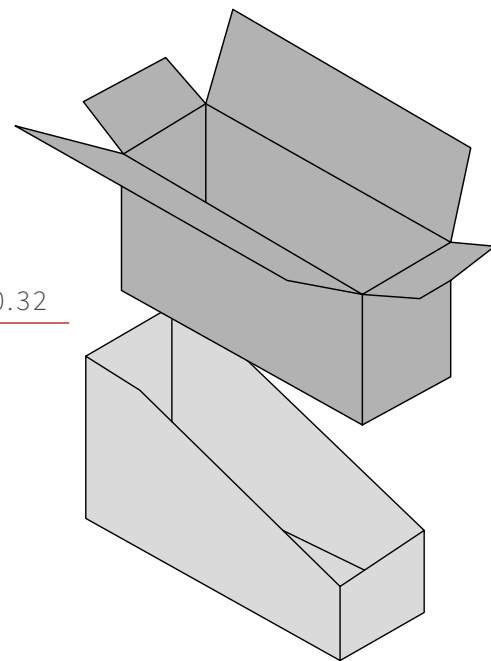

10

SCATOLE SPECIALI, INVIO CAMPIONI INDISPENSABILE

SPECIAL CARTONS, PLEASE SUBMIT SAMPLES

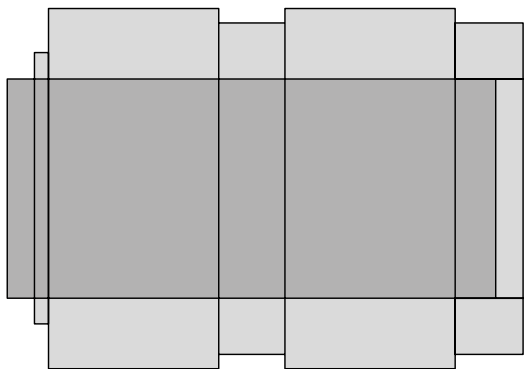

10.34

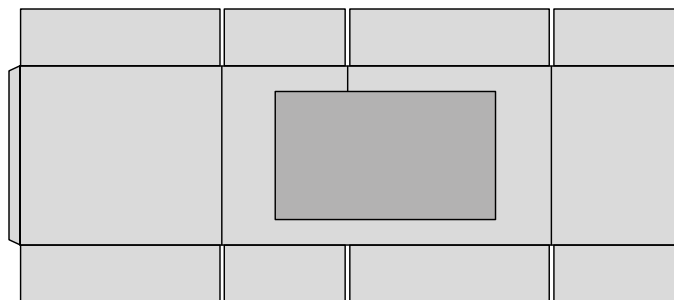
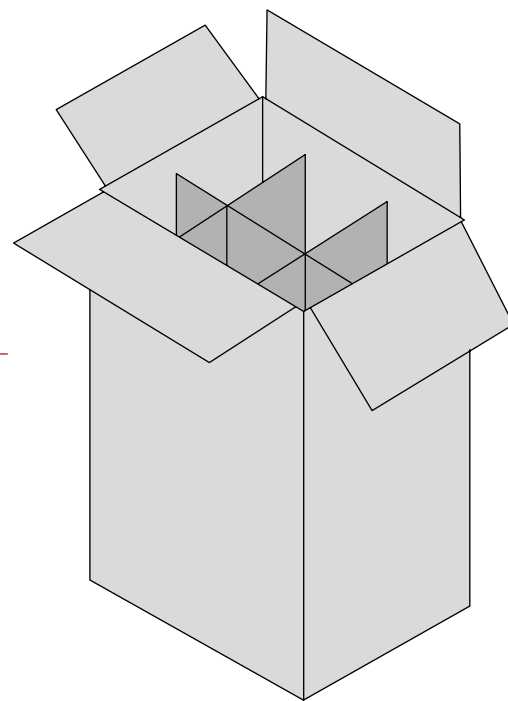

10.35

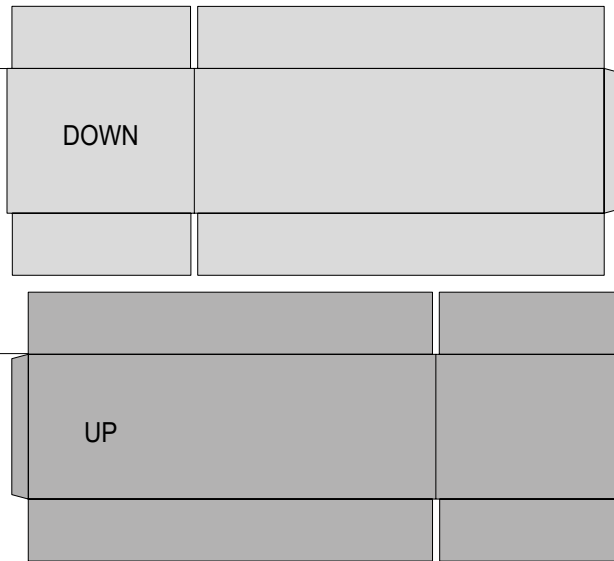

10.36

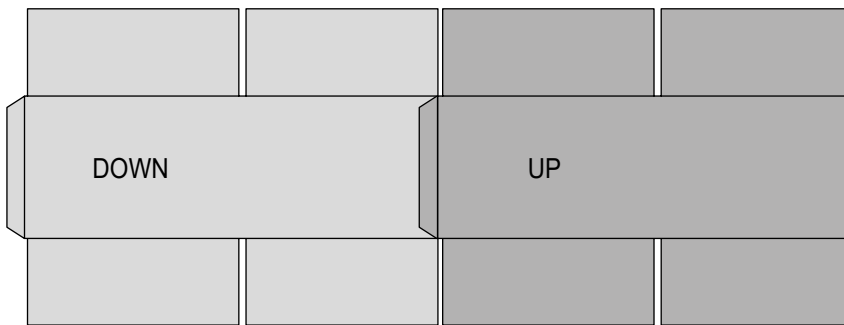
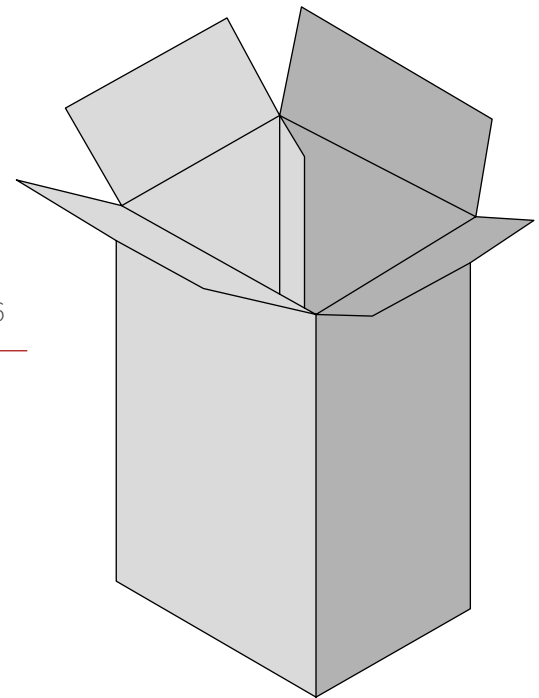

10.37

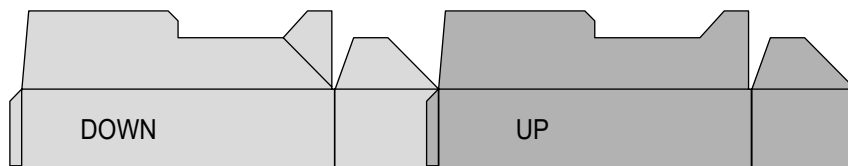

10.38

10

SCATOLE SPECIALI, INVIO CAMPIONI INDISPENSABILE

SPECIAL CARTONS, PLEASE SUBMIT SAMPLES

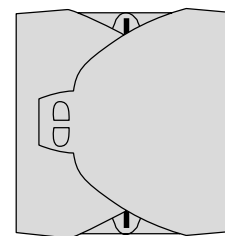
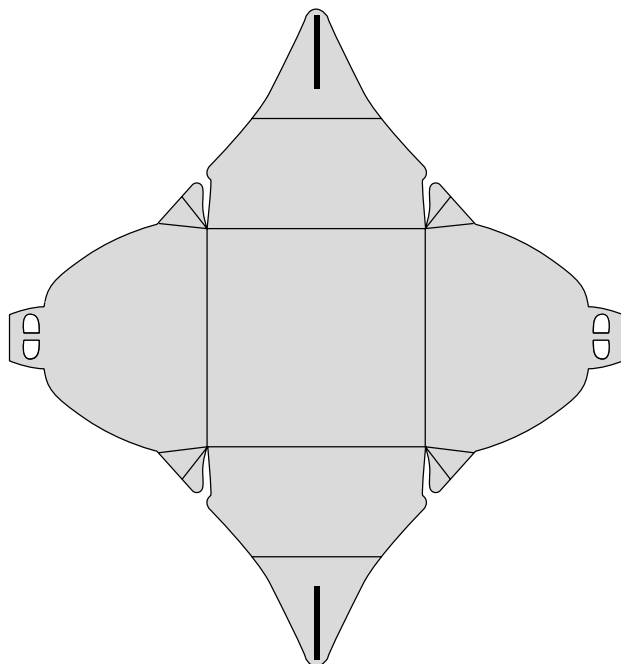

10.41

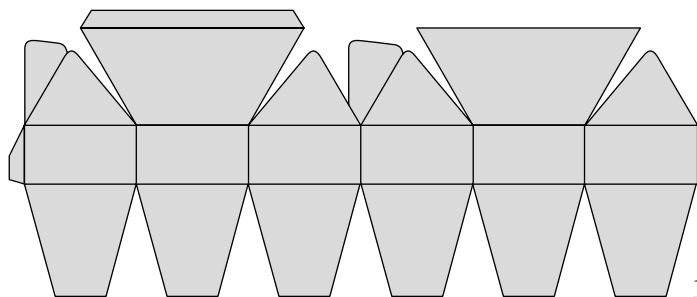

10.42

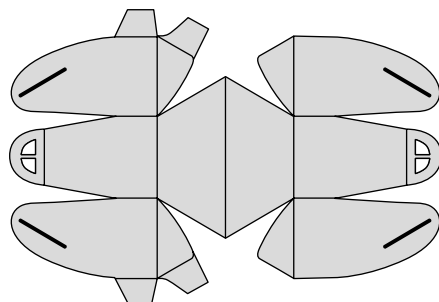
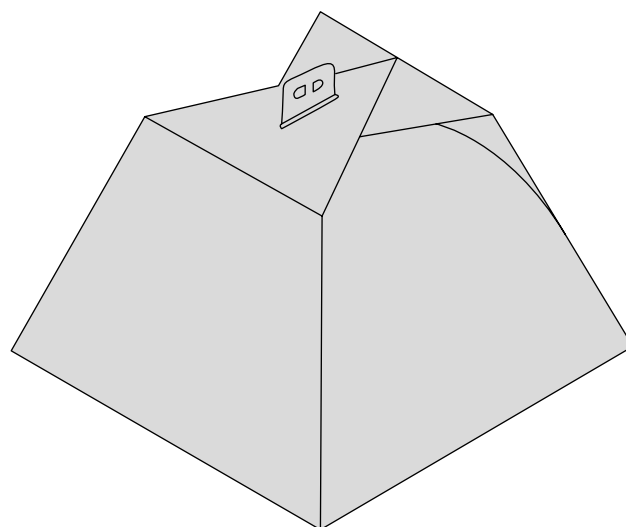

10.43

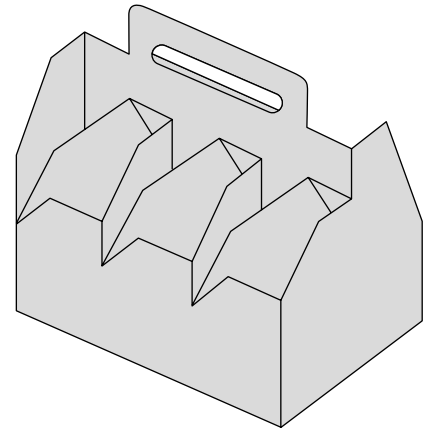
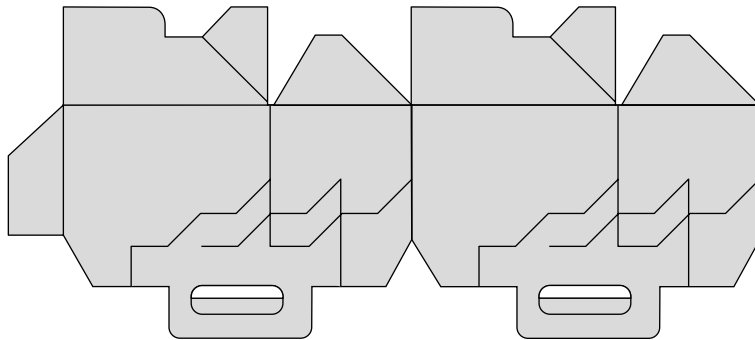

10.44

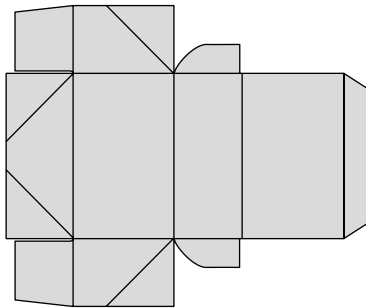

10.45

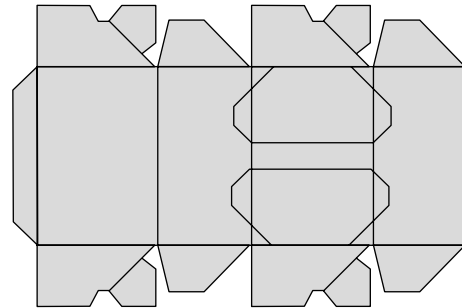

10.46



VEGA S.R.L.

VIALE DELL'INDUSTRIA, 6

20037 PADERNO DUGNANO ▪ MILANO ▪ ITALY

TEL. +39 02 99046212 ▪ FAX +39 02 99046202

COMM@VEGAGROUP.IT ▪ WWW.VEGAGROUP.IT