

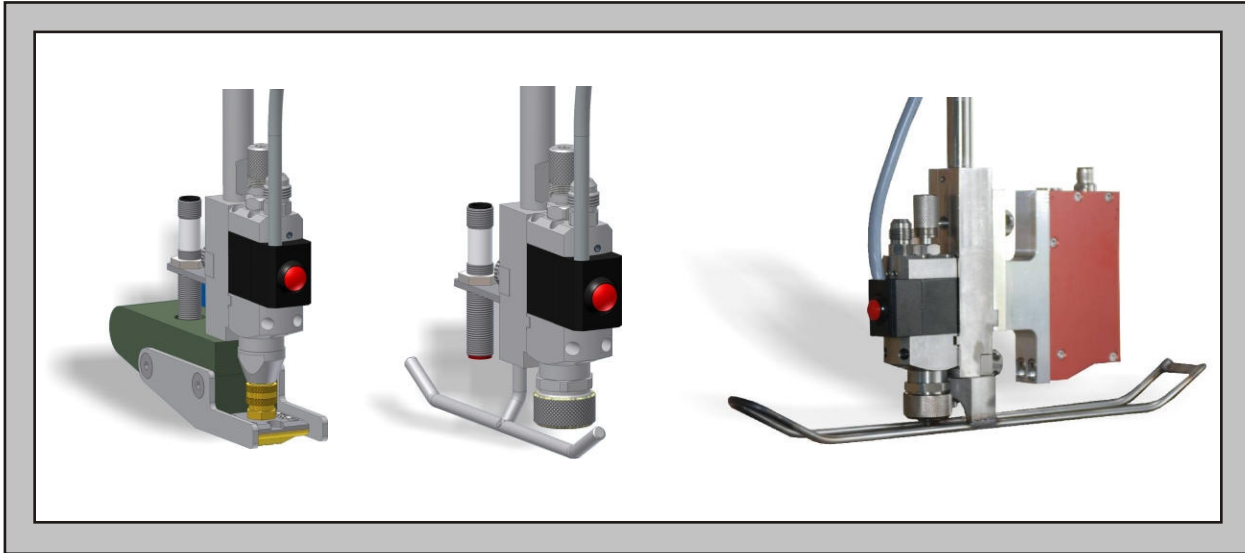

## 540BR & 540EC CONTACT/NON-CONTACT VALVES



The 540BR valve assemblies are available for contact gluing designed for use with the BoardRunner contact applicator heads, includes a PNP barrel scanner and bracket assembly for mounting to 16-30 mm square bar. Applicator head sold separately

540EC valves are designed for use with contact or non-contact nozzle assemblies. As above, the assembly includes a PNP barrel scanner and bracket assembly for mounting to 16-30 mm square bar. Specify gluing only or inspection ready - designed to accept the AS302 glue sensor. Nozzles sold separately.



NOTE: See SPECIALTY FOLDER GLUER SALES GUIDE for complete system details using the 540BR and 540EC valves.

The 540BR series valves are solenoid operated for precise glue patterns at high machine speeds. The male swivel seat adapter allows for the mounting of BoardRunner Applicator Head. The valve features a carbide tipped plunger assembly and no dynamic seals for long life. The 540BR can also be converted to a 540EC for non-contact applications. The 540BRR version offers an adjustable stroke for more flexible pattern control. The 540EC can also be converted to a 540BR for contact applications. The 540ECR version offers an adjustable stroke for more flexible pattern control.

540 Series Valves	
Technical Data	
Coil	5.3ohms
Valve Width	25mm
Fluid Pressure	400 psi
Viscosity	300-2500 cps
Hold Voltage	6VDC



## 540BR & 540EC CONTACT/NON-CONTACT VALVES

### Valve Mounting Brackets - 540 Series

- Following bracket assemblies do not include the glue valve

540 Series Mounting Brackets		
	PN	DESCRIPTION
<p>579xx421      579xx427</p>	579xx421	Mounting bracket, non-contact valve (ordered separately), with scanner bracket and scanner
	579xx743	Mounting bracket, non-contact valve (ordered separately), with out scanner bracket and scanner
	579xx427	Mounting bracket, contact valve (ordered separately), with scanner bracket and scanner
	579xx512	Mounting bracket, contact valve (ordered separately), with out scanner bracket and scanner

- Following bracket clamp for use on Post machines

540 Series Mounting Brackets		
	PN	DESCRIPTION
	579xx846	Bracket clamp adapter, Post machines



## 540BR & 540EC CONTACT/NON-CONTACT VALVES

### Complete Gluing Station 540EC Series Valve, Inspection Ready

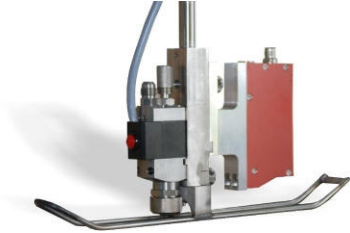
	PN	DESCRIPTION
	579xx517	540EC valve assembly, inspection ready, non-contact, for stainless-steel HACK. AS302 sensor and nozzle ordered separately.
		Above assembly includes: 707xx469 540EC valve assembly 280xx288 Scanner

**NOTE:** See SPECIALTY FOLDER GLUER SALES GUIDE for complete system details using the 540BR and 540EC valves.



## 540BR & 540EC CONTACT/NON-CONTACT VALVES

### 540BRT/BRR Contact Glue Valves

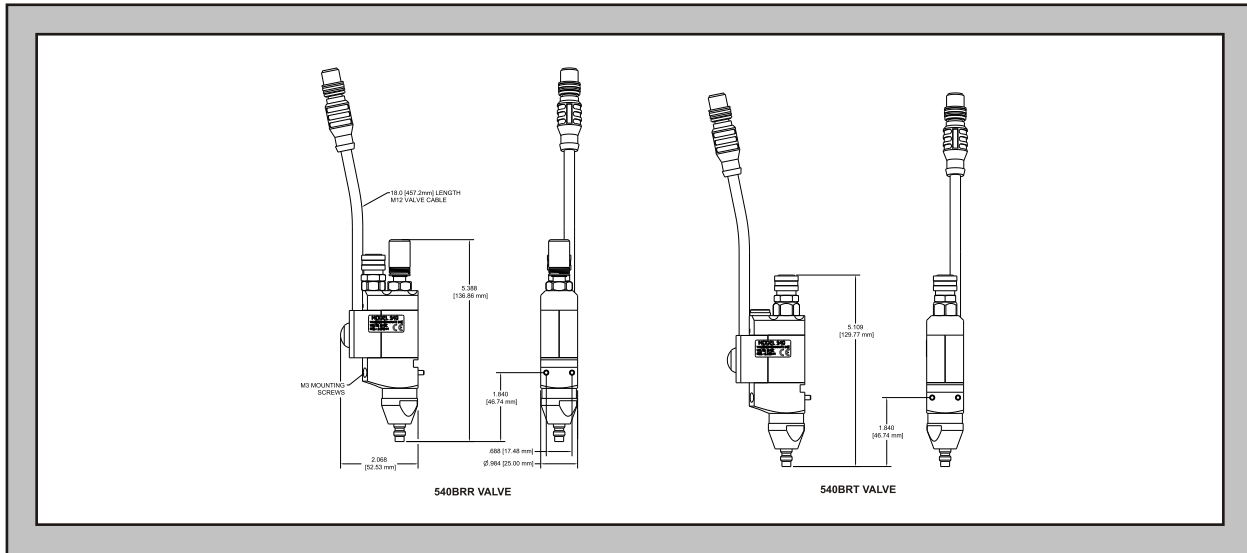

The 540BR series valves are solenoid operated for precise glue patterns at high machine speeds. The male swivel seat adapter allows for the mounting of BoardRunner Applicator Head. The valve features a carbide tipped plunger assembly and no dynamic seals for long life.

The 540BR can also be converted to a 540EC for non-contact applications. The 540BRR version offers an adjustable stroke for more flexible pattern control.

**NOTE:** Viton is standard seal material. EP seals are available as an option for adhesive formulas that react with the Viton (causing them to swell).

#### 540BRT/BRR Contact Glue Valves

	STD VITON	EP SEALS	DESCRIPTION TITLE
<p>707xx468 shown with 579xx427 mounting bracket, 280xx288 scanner and BoardRunner applicator head</p>	707xx467	707xx651	540BRT valve, non-adjustable stroke
	707xx468	707xx653	540BRR valve, adjustable stroke
	707xx447	707xx631	Maintenance Kit 540EC/BR. Maintenance kit includes lithium grease, flushing adapter nozzle cleaning drills, cleaning brush, o'rings and valve spring.

**NOTE:** BoardRunner applicator head ordered separately.



## 540BR & 540EC CONTACT/NON-CONTACT VALVES

540BR/T Components				
	ITEM	STD VITON	EP SEALS	DESCRIPTION
	1	799xx658	707xx607	Fitting Female Swivel
	2	707xx504	707xx615	JIC Coupler
	3	745xx339	746xx119	O-ring (included w/items 1,2)
	4	707xx472	707xx608	Back Stop Assembly Adjustable
	5	712xx014	712xx015	Back stop assembly, non-adjustable
	6	745xx340	746xx089	O-ring (included w/items 4,5)
	7	707xx477	707xx477	Valve Sub Assembly
	8	798xx049	798xx049	Socket Head Cap Screw
	9	783xx042	783xx042	Spring
	10	707xx482	707xx482	Plunger 4mm Ball
	11	745xx007	746xx170	O'ring (included w/item 14)
	12	746xx069	746xx069	O-ring (included w/item 13)
	13	707xx462	707xx462	Seat Assembly
	14	707xx459	707xx611	Applicator Head Adapter Assembly, includes Items 11,12 &13
Repair kits, include O-rings spring and mounting screws				
		712xx012	712xx013	Repair kit, 540 series



## 540BR & 540EC CONTACT/NON-CONTACT VALVES

### 540ECR/ECT Valves

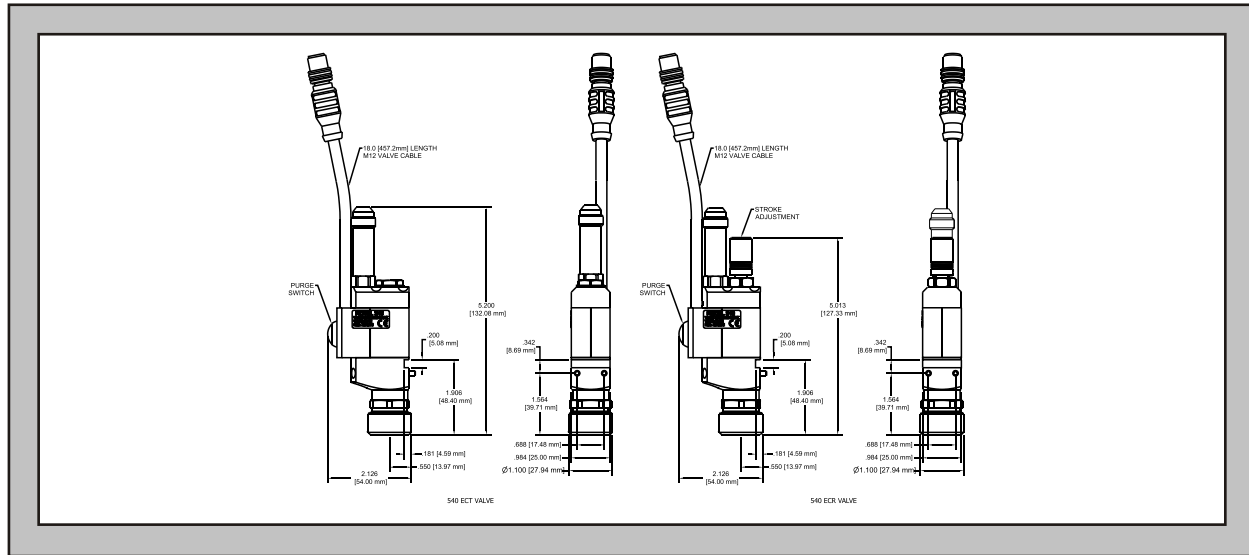

The 540ECR/ECT series valves are solenoid operated for precise glue patterns at high machine speeds. The valve features a carbide tipped plunger assembly and no dynamic seals for long life.

The 540EC can also be converted to a 540BR for contact applications. The 540ECR version offers an adjustable stroke for more flexible pattern control.

**NOTE:** Viton is standard seal material. EP seals are available as an option for adhesive formulas that react with the Viton (causing them to swell).

#### 540ECR/ECT Non-Contact Glue Valves

	STD VITON	EP SEALS	DESCRIPTION TITLE
 <p>707xx469 shown with 579xx421 mounting bracket, 280xx288 scanner and non-contact nozzle</p>	707xx466	707xx650	540 ECT valve, non-adjustable stroke
	707xx469	707xx652	540 ECR valve, adjustable stroke
	707xx447	707xx631	Maintenance Kit 540EC/BR. Maintenance kit includes lithium grease, flushing adapter nozzle cleaning drills, cleaning brush, o'rings and valve spring.



## 540BR & 540EC CONTACT/NON-CONTACT VALVES

### 540ECR/ECT Components

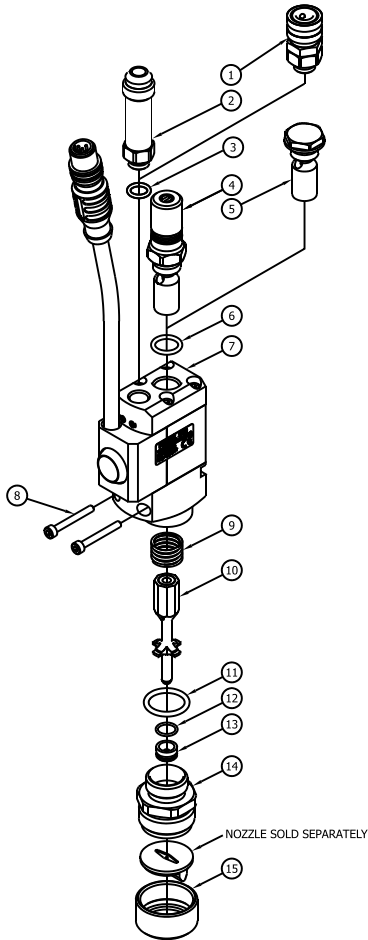



ITEM	STD VITON	EP SEALS	DESCRIPTION
1	799xx658	707xx607	Fitting Female Swivel
2	707xx504	707xx615	JIC Coupler
3	745xx339	746xx119	O-ring, included w/items 1, 2
4	707xx472	707xx608	Back Stop Assembly Adjustable
5	712xx014	712xx015	Back stop assembly, non-adjustable
6	745xx340	746xx089	O-ring, included w/items 4, 5
7	707xx477	707xx477	Valve Sub Assembly
8	798xx049	798xx049	Socket Head Cap Screw
9	783xx042	783xx042	Spring
10	707xx482	707xx482	Plunger 4mm Ball
11	745xx007	746xx170	O'ring, included w/item 14
12	746xx069	746xx069	O'ring, included w/item 14
13	707xx462	707xx462	Seat Assembly
14	707xx461	707xx612	Nozzle Adapter Assembly. Includes Items 11, 12, 13 & 15
15	707xx445	707xx445	Retaining Nut
Repair kits, include O-rings, spring and mounting screws			
	712xx012	712xx013	Repair kit, includes O-rings, spring and mounting screws

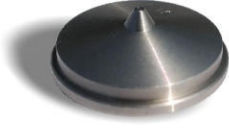
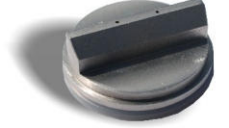

## 540BR & 540EC CONTACT/NON-CONTACT VALVES

### 540EC Valve - Nozzle Options

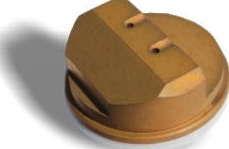

540EC Valve - Nozzle Options	
	PN DESCRIPTION TITLE
 707xx489	Single Vein Non-Contact Nozzles
	707xx489 Nozzle, 0.012 (.3mm)
	707xx488 Nozzle, 0.016 (.4mm)
	707xx487 Nozzle, 0.020 (.5mm)
	707xx486 Nozzle, 0.024 (.6mm)
707xx485 Nozzle, 0.028 (.7mm)	
 707xx458   707xx455   707xx497	Multi-Vein Non-Contact Nozzles
	707xx881 Nozzle, 2 vein .015(0.4mm), .250 spacing
	707xx882 Nozzle, 2 vein .020(0.5mm), .250 spacing
	707xx883 Nozzle, 2 vein .024(0.6mm), .250 spacing
	707xx884 Nozzle, 2 vein .031(0.8mm), .250 spacing
	707xx885 Nozzle, 3 vein .015(0.4mm), .250 spacing
	707xx886 Nozzle, 3 vein .020(0.5mm), .250 spacing
	707xx887 Nozzle, 3 vein .024(0.6mm), .250 spacing
	707xx888 Nozzle, 3 vein .031(0.8mm), .250 spacing
	707xx889 Nozzle, 4 vein .020(0.5mm), .250 spacing
	707xx890 Nozzle, 4 vein .024(0.6mm), .250 spacing
	707xx891 Nozzle, 4 vein .031(0.8mm), .250 spacing
	707xx892 Nozzle, 5 Vein 0.6mm diameter 0.125 centers
	707xx893 Nozzle, 7 Vein 0.6mm diameter 0.125 centers
707xx449 Old-style nozzle replacement nozzle insert - Bulletin116	
Contact Nozzles	
707xx498 Contact nozzle assy, 0.39 (1mm), single vein	
707xx497 Contact nozzle assy, 0.39 (1mm), 0.25(6.35mm) centers two vein	
707xx496 Contact nozzle assy, 0.39 (1mm) 0.25 (6.35mm) centers three vein	
707xx495 Contact nozzle assy, 0.39 (1mm) 0.236 (6mm) centers 4 vein	



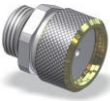
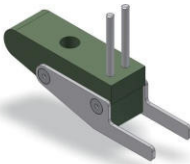

## 540BR & 540EC CONTACT/NON-CONTACT VALVES

### Non-Contact / Contact Conversion Kits

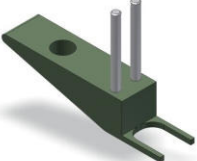
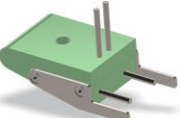
Conversion Kits Contact/Non-Contact 540 Valve		PN	DESCRIPTION
 579xx520  707xx461	707xx299	Conversion kit, contact to non-contact 540 valve, includes 707xx461 Nozzle adapter assembly 579xx520 Guide foot assembly	
 579xx429  707xx459	707xx297	Conversion kit, non-contact to contact 540 valve, includes 707xx459 Applicator head adapter assembly 579xx429 Guide foot assembly	
 579xx422	707xx298	Conversion kit, J&L specific, contact to non-contact 540 valve, includes 707xx461 Nozzle adapter assembly 579xx422 Guide foot assembly	
 579xx828	579xx878	Guide foot assembly, for use with applicator heads wider than 5-vein	