



Total Solutions Provider of Gluing & Inspection Systems for  
**SPECIALTY FOLDER GLUERS**



Adhesive Dispensing & Quality Assurance Systems

# INTRODUCTION

Shelf-ready packaging is the key. Specialty gluers are called on as a solution to make the product stand out. Clever box design, high-quality printing, and precision die-cutting are all key elements. The ability to produce various styles and sizes of boxes further enhance a box maker's success.

Valco Melton gluing systems for specialty gluers are versatile, capable of contact or non-contact gluing, at high or low pressures, ribbons or bead patterns, with cold glue or hot melt adhesives. In many cases a combination of components are used together, successfully producing the most complex product at the highest possible speed. In addition to performance and flexibility the Valco Melton equipment offers fast set up and changeover and can be adapted to new or older machines.

As support for providing superior gluing equipment, Valco Melton offers ClearVision, high-speed camera-based inspection systems that offer 100% inspection of gluing, printing, folding, window and foil verification, as well as code reading.

- The Valco Melton system offers the ability to easily change from one to another, from contact to non-contact, hot melt or cold glue, offering system flexibility unmatched by any other supplier
- Rugged valve mounting brackets permit repositioning of glue valves as needed for changing product designs
- Control systems are designed for easy operator setup and changeover. Multi-channel, full featured units include automatic adhesive pressure control, jam prevention, and batch count capabilities.
- Quality assurance inspection functions include: GlueChek, FoldChek, CodeChek, ScoreChek, PrintChek and others
- Systems are modular allowing users to easily expand, add gluing stations, or inspection features as needs change.
- As equipment and needs evolve, Valco Melton provides cost effective rebuild/exchange/upgrade programs to ensure that production levels remain at the leading edge.

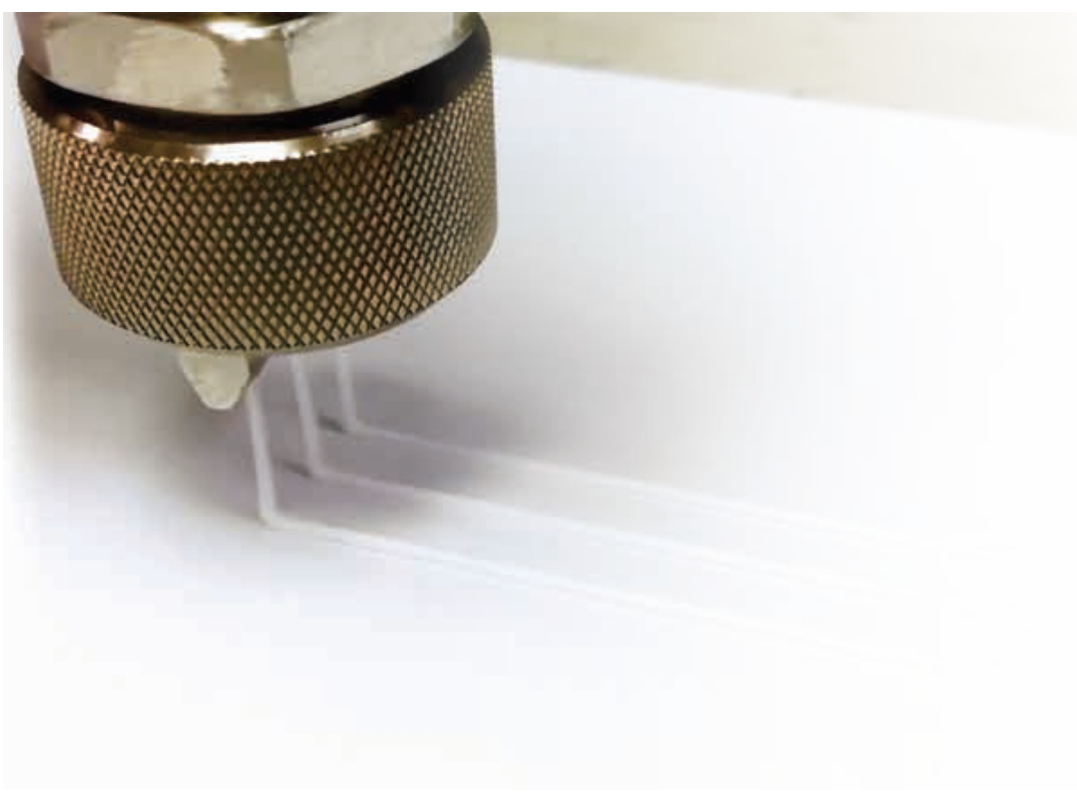

**MCP-4J**

- 4-Valves, 4-Scanners
- Auto-configuring voltage 90-240VAC
- Internal/External Pressure Control
- Job Storage (100)
- Inch/Metric
- LED display plus push-button overlay
- Auto-Glue mode
- OEM Communication
- Pulse-Purge
- Jam Preventer (4 or 8 Channel)
- Stitched patterns - jog on restart
- Data sharing with CartonChek 7
- USB port for system backups and software updates.
- Batch Count
- Scanner Lockout
- Vertical or Horizontal Mounting



**MCP-8**

- 8-Valves, 8-Scanners
- Jam Preventer (4 or 8 Channel)
- Auto-configuring voltage 90-240VAC
- Internal/External Pressure Control
- Job storage (100)
- Inch/Metric
- 4.5" Color touch-screen
- Alarm/Relay outputs
- Remote mount screen option
- Backup/Restore to/from external media
- Data sharing with CartonChek
- OEM Communication
- Auto-Glue mode
- Pulse-Purge
- Stitched patterns - jog on restart
- Scanner Lockout
- Batch Count



**MCP-8I**

- 4-Valves, 3-Inspection Sensors, 1 ejector
- Jam Preventer (4 or 8 Channel)
- Auto-configuring voltage 90-240VAC
- Internal/External Pressure Control
- Job storage (100)
- Inch/Metric
- 4.5" Color touch-screen
- Alarm/Relay outputs
- Remote mount screen option
- Backup/Restore to/from external media
- Data sharing with CartonChek
- OEM Communication
- Auto-Glue mode
- Pulse-Purge
- Stitched patterns - jog on restart
- Scanner Lockout





## VCX/OT-120



- Up to 16 channels in modules of 4 in any combination of sensors and valves
- Jam Preventer (up to 16 channels)
- Auto-configuring voltage 90-240VAC
- Internal Pressure Control (up to 4)
- External Pressure Control (up to 4)
- Easily recognized icon-based access to gluing inspection
- Job Storage (1000)
- Batch, supports tracking and all forms of ejection
- Inch/Metric
- 12" Remote-mount Color touch-screen
- Data sharing with CartonChek 7
- OEM Communication
- Auto-Glue mode
- Pulse-Purge
- Stitched patterns - jog on restart
- Scanner Lockout
- Quality data collection and reporting
- SupportChek remote service access



### 524 VALVE

---

- Adjustable flow rate for precision high-speed patterns
- Integrated purge/test switch
- Capable of high pressure operation (up to 500 psi)
- Compatible with a range of adhesive viscosities (up to 4000cps)
- Ceramic on ceramic ball and seat

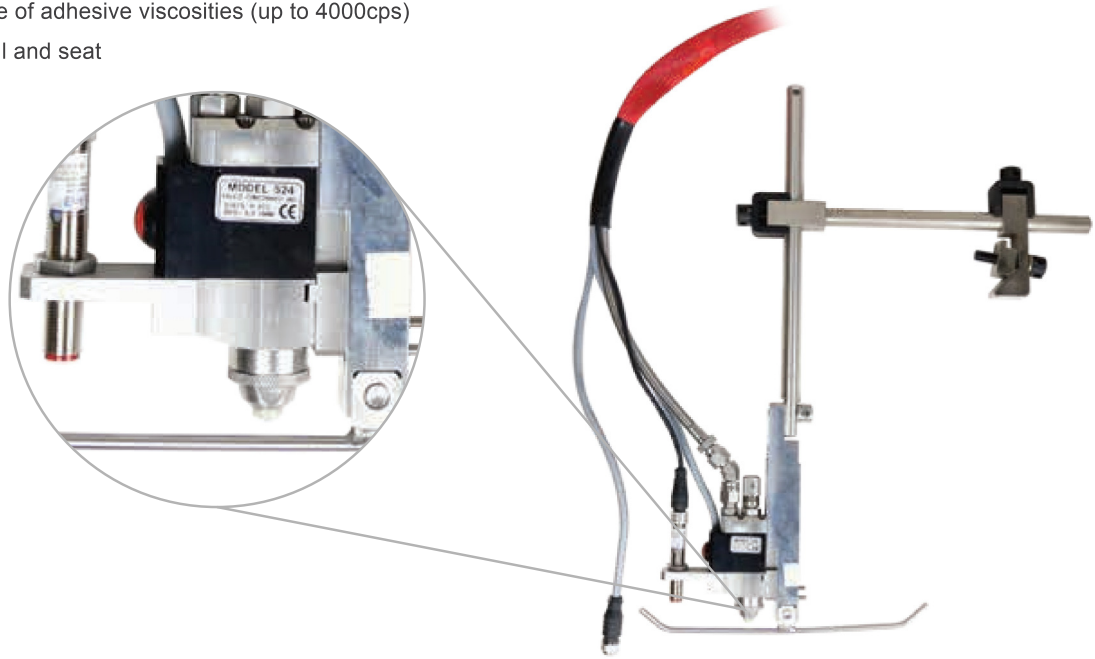

### 524 EXTENDED NOZZLE BODY VALVE

---

- Adjustable flow rate for precision high-speed patterns
- Integrated purge/test switch
- Capable of high pressure operation (up to 500 psi)
- Compatible with a range of adhesive viscosities (up to 4000cps)
- Extended nozzle body permits positioning close to machine rails for installation flexibility
- Ceramic on ceramic ball and seat

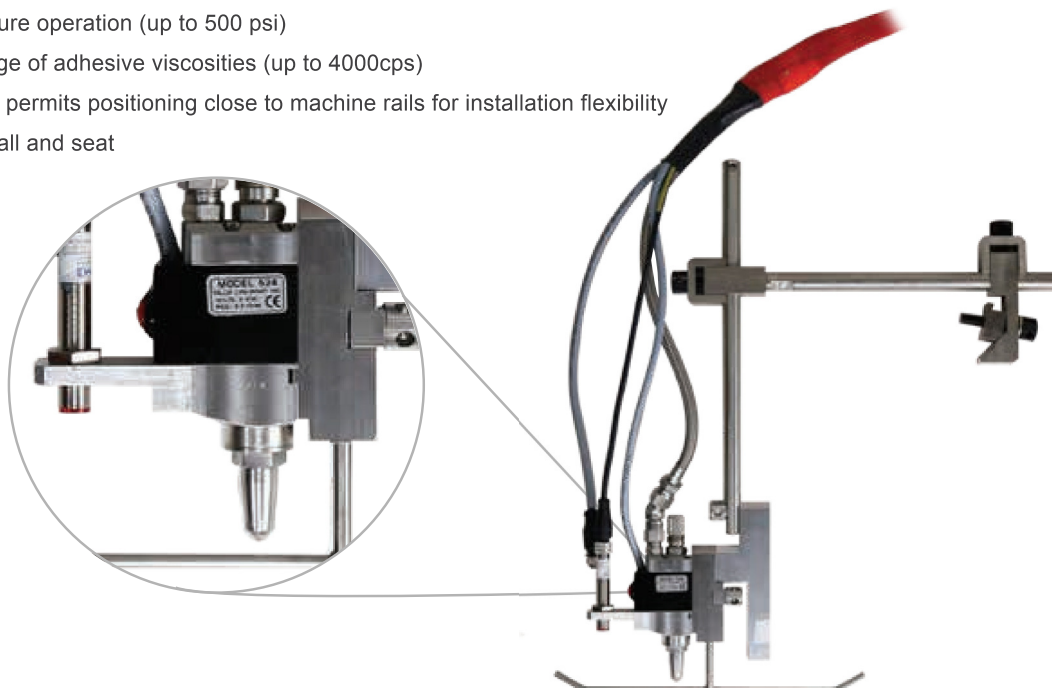

## 540 SERIES

The Valco Melton 540 Valve for single and multi-orifice nozzles can convert quickly from non-contact to contact. A variety of available contact applicator heads apply pattern widths up to 3 inches, come with a built-in purge switch, and are available in a rear-adjust version. This valve has a high flow rate and dispenses viscosities up to 4,500 mPas. Suitable for high speed patterns, dotting, and dispensing high glue pressures up to 500 psi (35 bar), the Valco® 540 Series Valve is the ideal solution for replacing pneumatic technology on specialty gluers.

- High cycle rate offers superior dot application
- High flow rate
- Clean pattern cut off at all machine speeds
- Long service life
- Sealed mechanical purge switch
- Engineered ceramic seat
- Contact application widths up to 3 inches (75 mm)
- Non-contact, single or multiple bead patterns up to 1 inch (25mm) wide

### 540 Series Valve Options:

540BR- Contact, 4 mm ball plunger, accepts entire BoardRunner series of contact heads

540EC- Non-contact, 4 mm ball plunger, 1" retainer nut for non-contact nozzles up to 1" wide patterns, multi-bead or single bead



Contact Version



Multi-Orifice Non-Contact Version

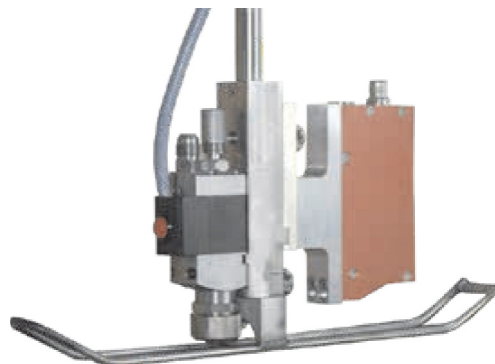

Non-Contact Version with Glue  
Pattern Inspection

Single orifice, multi-orifice, contact and non-contact design. Valco Melton can provide an applicator/nozzle to meet nearly any carton design and style.

Offered in stainless-steel and hardened tool-steel (for contact applications) the nozzles are designed to run clog-free and offer long service life. They are chemical resistant and can easily be cleaned for use with different types of adhesives.

Orifice diameter and spacing can be selected according to the pattern required coupled with the viscosity of the adhesive. As standard they are available for pattern requirements from single bead to contact pattern width of 2 3/4 inch (70mm). They are also easily changed out as carton designs vary.

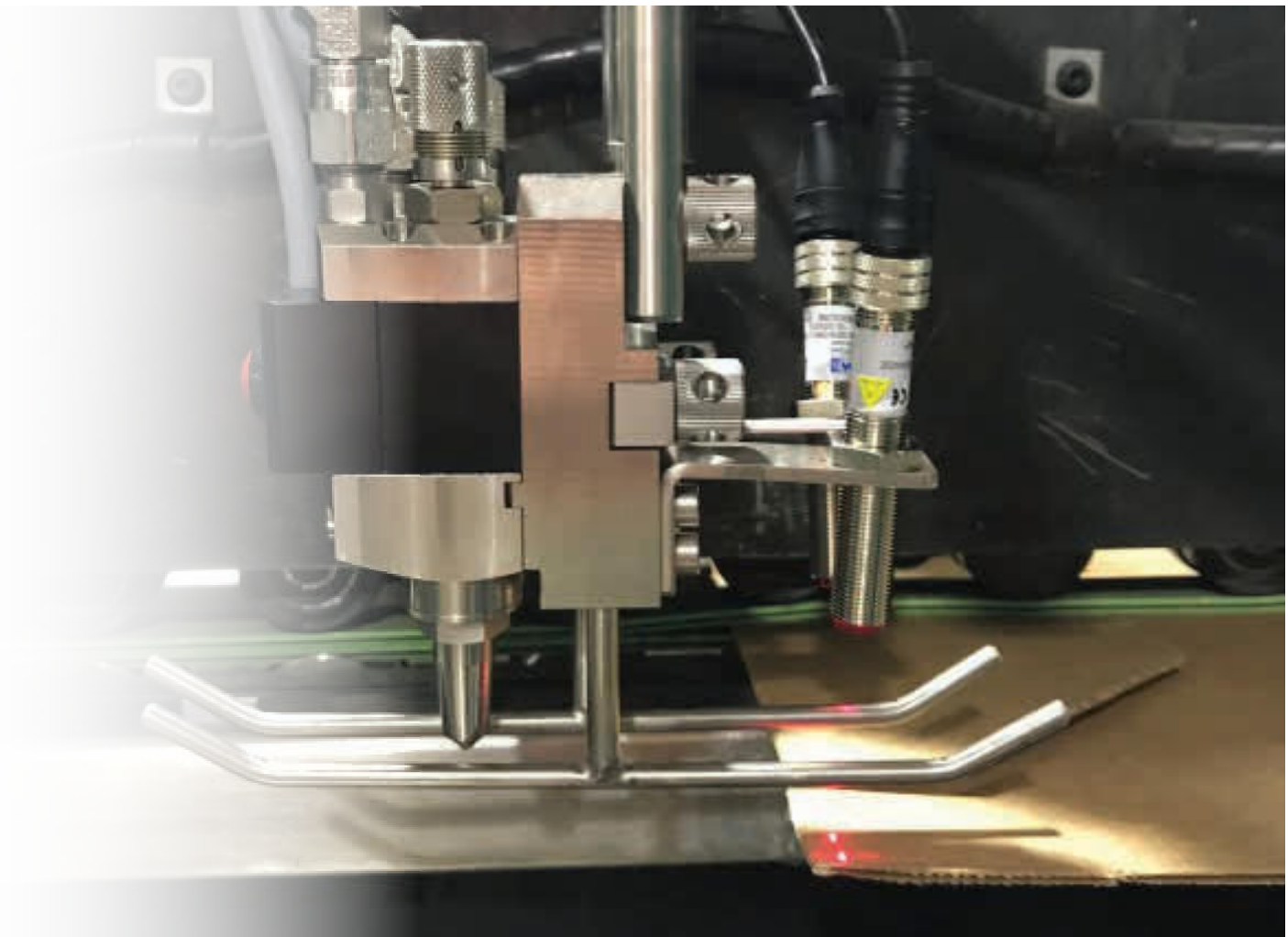
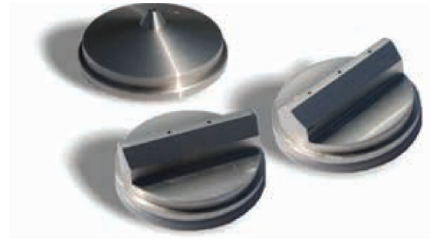



# PUMPING SYSTEMS & BALANCING REGULATORS

## 1:1, 3:1, 6:1 BALANCING REGULATOR

- Pressure balancing regulator - relieves excessive pressure that occurs during high speed stops
- Ultra-precise and fast pressure control
- No shaft seals
- Easy rebuild
- No pattern flooding at restart
- Rolling diaphragm design for frictionless movement and no losses



## DD-1

- Trusted reliability of a 1:1 diaphragm pump
- Electronic shifting
- High flow rate
- Suction from totes, drums, and pails
- 1/2 NPT and 1/2 BSPP inlet/outlet fittings
- 24VAC source from Valco Melton controls or optional transformer
- Wall mount, pail mount, or drum mount

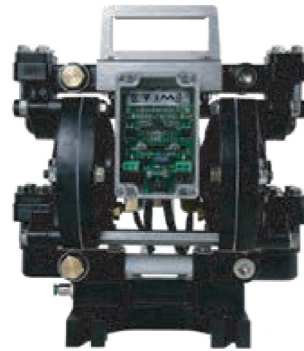

## EPP-9

- High flow-rate 9:1 piston pump
- Electronic reversing
- Intelligent SLOW MODE feature prevents high cycle rates that occur during priming or when adhesive supply is blocked or depleted (dry cycling).
- Can communicate adhesive consumption and maintenance intervals with select glue pattern controllers
- Advanced seal technology offers extended reliability



## PFRM-5

- Complete assembled package, 14:1 pump, 5:1 balancing regulator, 4-port manifold, and filter
- Shaft/seal cartridge for fast and simple repair
- Drum mount, wall mount, and pail mount options





## MXM SERIES VALVES, SIDE-FEED OR TOP-FEED

Valco Melton's MXM electric hot melt valve is the workhorse for most Valco Melton hot melt dispensing solutions. The MXM electric valve can operate at extremely high speeds reaching 15,000 cycles per minute for short bursts and are capable of more than 2 billion cycles before requiring service.

Combine the speed of hot melt with the strength of cold glue.

- Cost-effective solution
- Maximize production
- Clean application
- Fast system payback
- Side feed or top feed assembly

### MXM SERIES VALVES



## ME VALVE

Valco Melton's ME Double Effect Dispensing Gun Series introduces one of the most advanced technologies for high velocity intermittent bead applications to the hot melt gluing market. Thanks to its double effect module system, the ME Series ensures a perfect and uniform adhesive cut, giving a clean, quality appearance for stronger product finishing. The ME applicator offers a flexible and versatile design, adaptable to market standards, which offers a universal installation and easy configuration for all application demands.

- 100% compatible to market standards
- Up to 2,400 cycles per minute
- Single and multi-module designs
- Flexible configurability and installation



ME SERIES VALVE

# THE HOT MELT ALTERNATIVE

## GEAR PUMP OR PISTON PUMP MELT UNITS

Valco Melton's D4, D10, and D16 Series Units are ideal for high speed folding carton applications. All D Series units feature an LED display, spur gear pump with fixed or variable speed, "key-to-line" control, and a multi-functional control system. Other options include an integrated glue pattern control, line speed pressure control and integrated auto-feed systems.

- Achieve uniform output pressure to match line speed with built-in pressure run-up control
- Easy-to-connect HMI communication through the melter interface I/O's

The EC series units design is a culmination of features that have been crafted in response to communication with hot melt unit users worldwide. Valco Melton's new EC Series hot melt adhesive unit offers optimum reliability and total control of the unit's operation. Supported by the most current features and technology, the Valco Melton EC series unit easily takes recognition as the best in its class.

- User-friendly control panel
- Air-powered piston pump

**D SERIES GEAR PUMP UNITS**  
4, 10, 16 KG TANKS



**EC SERIES PISTON PUMP UNITS**  
4, 8, 14KG TANKS



## PUR

Valco Melton's IsoMelt Mini and D4 PUR Series are designed to process reactive hot melts such as PUR. Units feature a fully integrated, multi-functional controller that is accessible from a user-friendly screen, which allows for fast and easy configuration changes and provides "key-to-line" capabilities.

- Ideal for plastic packaging
- Swiveling tank lid allows for faster changes of PUR slugs, minimizing downtime

**Also available with Pail Unloader**

**IsoMelt Mini**



**D4-PUR**



**Pail Unloader**





**Decrease your material cost by 40% or more**

Streamline production and improve the quality of your deferred-use packaging products using Valco Melton's SealTak® System. Compared to double-sided pressure sensitive tapes, the SealTak system offers a more cost-effective and efficient sealing process by using pressure-sensitive adhesive and a release liner.

**Get these immediate benefits**

- Increase production and reduce downtime by eliminating the need for excessive tape roll changes
- Reduce material costs—the cost of buying bulk adhesive and bulk silicone paper is far less than transfer tape
- Produce a stronger bond by evenly depositing adhesive onto the substrate



**Deferred-Use Packaging System**

**Turning Significant Profit.**

Molten hot melt adhesive is evenly applied onto the substrate in ribbon, bead, or spray form during the converting process. The release liner is then deposited over the adhesive with an offset, which allows for the easy peel and seal feature that is



**Release Liner Staging Unit**

**A Process Made Simple.**

A release liner is fed through the "accumulator" to the liner's applicator head and then deposited onto the adhesive just downstream from the gluing area. Then, a release liner is fed through the "Accumulator" to the liner applicator head and deposited on the adhesive just downstream from the gluing area. A process made simple with SealTak®.

**FlexMelt**

Valco Melton's FlexMelt Series hot melt units are ideal for use with SealTak® system. Teflon® coated tank and efficient cast-in heating elements offer clean, efficient operation. Units feature over-temperature and over-pressure protection for safe operation. Several tank sizes are available.



**Typical SealTak® System with Machine Mount Stand**

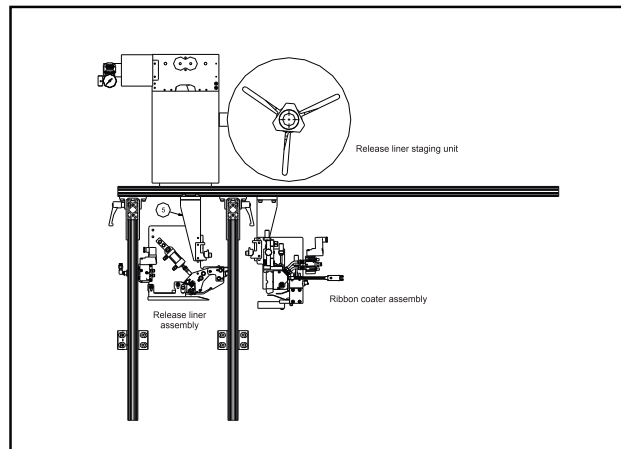

# INSPECTION SENSORS

## AS303/AS303H GLUE INSPECTION

---

- Fine Resolution: 1mm
- Compact Size: 21mm wide x 115mm tall x 60mm deep
- Functions with Quality Assurance Systems: CartonChek, VCX, MCP-8i
- High speed inspection for cold glue and hot melt adhesives
- No UV additive required



## BAR CODE READER

---

- Code 39
- Codabar
- Code 128
- Interleaved 2 of 5
- Code 93
- UPC / EAN / Pharma
- OMR (Optical Mark Recognition)



## DIGITAL SENSORS FOR CUSTOM DETECTION NEEDS

---

- Length and skew detection
- Flap detection





## KICKER

The Valco Melton Kicker is ideally suited for batch counting and reject kicking applications. The kicker offers a fast cycle time for smaller cartons and compact design for flexible mounting requirements.

- Single kick eject
- Dual kick and count eject optional



## MARKING VALVE

- Compact system package provides identification of faulty product
- Stainless steel tank
- All-electric, jetting or spray valve options
- Optional UV lamp kit



## SYSTEM STANDS

Valco Melton offers several options for system stands. The system stand significantly reduces initial installation time and provides a clean, organized installation for improved operator interface.

- Floor mount, machine mount or optional casters
- Diaphragm pump or piston pump
- Single or multiple glue pressure regulators
- Selected for any common Valco Melton control



System stand options are available for any system configuration

# VISION & INSPECTION SYSTEMS

## HOW IT WORKS

---

Work with your glue system and ClearVision inspection cameras with one screen using BoxChek7 inspection software. BoxChek7 brings users complete information on production line performance in real time. The screen simultaneously displays job statistics, defect images and history bar to facilitate analysis.

## BENEFITS

---

- Detect and identify defective gluing (hot melt or cold glue), folding, barcodes, print registration, corrugator scores, as well as issues with sheets such as skew.
- Minimize configuration times with the system's ability to learn the position of the cameras and sensors.
- Streamline support sessions using the online chat window.
- Intuitive interface that displays real time images and data from each of the installed systems.
- Defect and performance data for all boxes stored locally in SQL database and can be easily accessed remotely with MeasurementChek.

## SYSTEMS

---



GLUECHEK



SCORECHEK



FOLDCHEK



BUNDLECHEK



PRINTCHEK



GAPCHEK



REGCHEK



CODECHEK

MAKING QUALITY VISIBLE

## GLUECHEK



GlueChek takes a picture of every glue pattern. The system analyzes the glue pattern to ensure that no gluing problems exist. When a gluing problem is found, GlueChek shows the defect on the screen with a large "X", notifies operators by alarm, then marks the defective box and saves an image of the gluing problem.

By identifying and removing all defects before shipment, box makers can now provide 100% perfectly glued boxes to their customers. Having saved a picture of every defect builds operator confidence, helps maintenance troubleshoot, checks for skewed boards, and increases customer satisfaction.

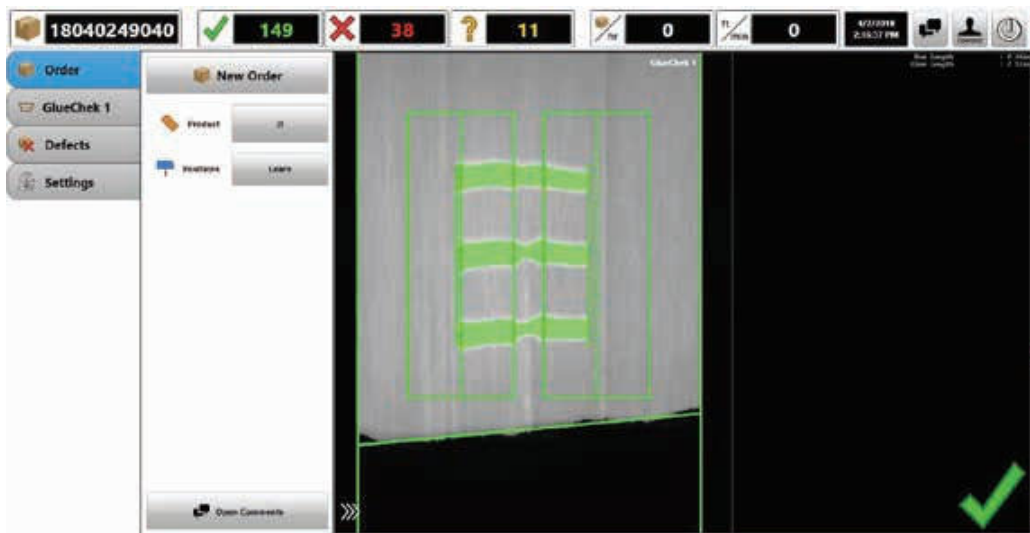
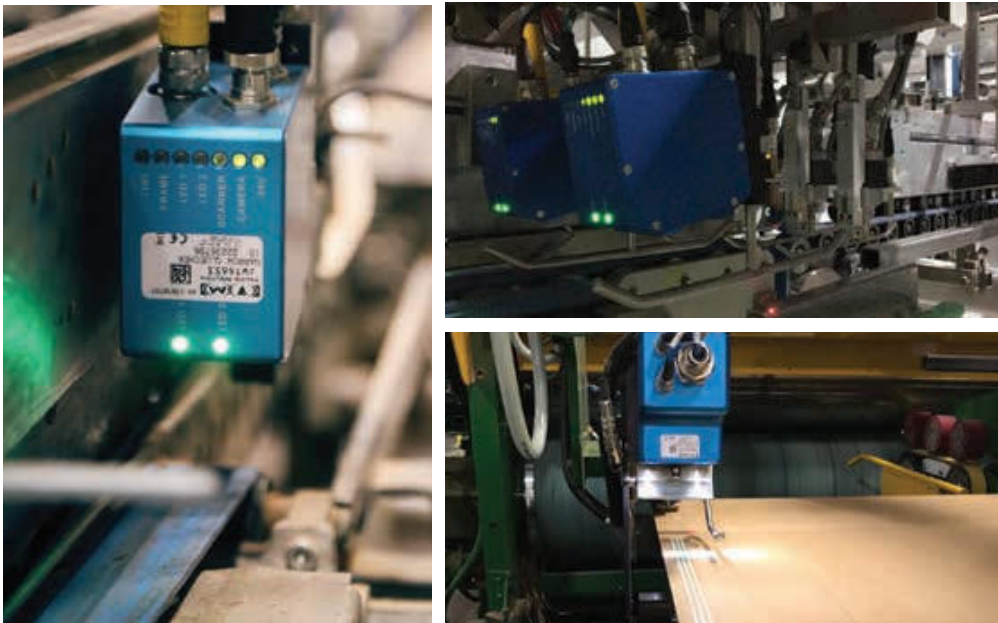

**World Headquarters**

**USA, OH, Cincinnati** | Tel: +1.513.874.6550  
inquiry@valcomelton.com

**America Manufacturing, Sales & Service Centers**

**USA West Coast**, Petaluma, CA

**GMS-Vansco**

Tel: +1.707.285.3392

inquiry@gmsvansco.com

**México**, Ciudad de México

Tel: +52.55.6278.1727

mexico@valcomelton.com

**Colombia**, Bogotá

Tel: +57.313.421.0926

colombia@valcomelton.com

**Brasil**, São Paulo

Tel: +55 11 3071 2117

brasil@valcomelton.com

**Europe Manufacturing, Sales & Service Centers**

**Spain**, Navarra, Orcoyen, | Tel: +34 948 321 580  
spain@valcomelton.com

**France**, Valence | Tel: +33 (0) 4 75 78 13 73  
france@valcomelton.com

**Italy**, Brescia | Tel: +39 030 273 2544  
italy@valcomelton.com

**Benelux**, The Netherlands | Tel: +31 252-673673  
benelux@valcomelton.com

**Hungary**, Budapest | Tel: +36 1-214-4705  
hungary@valcomelton.com

**UK**, England, Telford | Tel: +44 1952-677911  
uk@valcomelton.com

**Germany**, Düsseldorf | Tel: +49 211 984 798-0  
germany@valcomelton.com

**Poland**, Siechnice | Tel: +48 71 889 04 50  
poland@valcomelton.com



Direct Sales Centers ●  
Distributors Worldwide ●

**South, Southeast, West & Central Asia Manufacturing, Sales & Service Centers**

**Turkey**, Istanbul | Tel: +90 212 327 99 71  
turkey@valcomelton.com

**India**, Bangalore | Tel: +91.80.28378111  
india@valcomelton.com

**UAE**, Sharjah | Tel: +971.521305960  
uae@valcomelton.com

**Singapore**, Singapore | Tel: +65 850 95355  
singapore@valcomelton.com

**East Asia Sales & Service Centers**

**China**, Shanghai | china@valcomelton.com  
**China**, Xiamen | Tel: +86.592.591.7854  
Fax: +86.592.591.7834 | china@valcomelton.com

To find the office nearest you, visit:  
<http://bit.ly/2Cb8Fv2>  
snap a picture of this QR code



BC-004