



World Headquarters

USA, OH, Cincinnati | Tel: +1.513.874.6550
info@valcomelton.com

America Manufacturing, Sales & Service Centers

Canada, Vancouver, B.C.
ClearVision Technologies
Tel: +1.604.998.4012
canada@valcomelton.com

USA West Coast, CA, Petaluma
GMS-Vansco
Tel: +1.707.285.3392
inquiry@gmsvansco.com

Mexico, Mexico D.F.
Tel: +52.55.6278.1727
mexico@valcomelton.com

Colombia, Bogotá
Tel: +57.313.421.0926
colombia@valcomelton.com

Brazil, Sao Paulo
Tel: +55.11.3071.2117
brazil@valcomelton.com

Europe Manufacturing, Sales & Service Centers

Spain, Navarra, Orcoyen | Tel: +34 948 321 560
spain@valcomelton.com

France, Valence | Tel: +33 (0) 4 75 78 13 73
france@valcomelton.com

Italy, Brescia | Tel: +39 030 2732544
italy@valcomelton.com

Italy, Brescia | ERO s.r.l | Tel: +39 030 2731503
info@ero-glue.com

Benelux, The Netherlands | Tel: +31 252-673673
benelux@valcomelton.com

Hungary, Budapest | Tel: +36 1-214-4705
hungary@valcomelton.com

UK, England, Telford | Tel: +44 1952-677911
uk@valcomelton.com

Germany, Düsseldorf | Tel: +49.211 984 798-0
germany@valcomelton.com

Poland, Długołęka | Tel: +48 71 888 04 50
poland@valcomelton.com

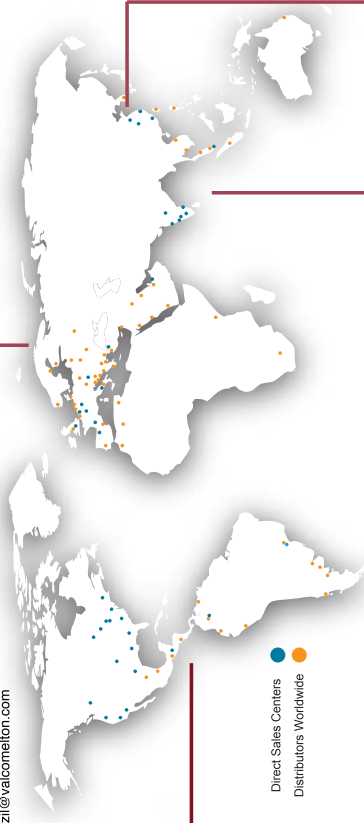

Direct Sales Centers
Distributors Worldwide

South, Southeast, West & Central Asia Manufacturing, Sales & Service Centers

Turkey, Istanbul | Tel: +90 212 327 99 71
turkey@valcomelton.com

India, Bangalore | Tel: +91.80.4655.3300
india@valcomelton.com

UAE, Sharjah | Tel: +971.521.305960
uae@valcomelton.com

Singapore, Singapore | Tel: +65 850 95355
singapore@valcomelton.com

East Asia Sales & Service Centers

China, Shanghai | china@valcomelton.com
China, Xiamen | Tel: +86.592.591.7854
Fax: +86.592.591.7854 | china@valcomelton.com



To find the office nearest you, visit: <http://bit.ly/2Cb8Fv2> or snap a picture of this QR Code

BC-004

KBB 000026 EN 001

valcomelton.com



VALCO MELTON
Adhesive Dispensing &
Quality Assurance Systems

ERO
GLUING SYSTEMS
A Valco Melton Company

Total Solutions Provider of Gluing & Inspection System to the
FOLDING CARTON INDUSTRY

MCP-4J



- 4-Valves, 4-Scanners
- Auto-configuring voltage 90-240VAC
- Internal/External Pressure Control
- Job Storage (100)
- Inch/Metric
- LED display plus push-button overlay
- Auto-Glue mode
- OEM Communication
- Pulse-Purge
- Stitched patterns - jog on restart
- Data sharing with CartonChek
- USB port for system backups and software updates.
- Batch Count
- Scanner Lockout
- Vertical or Horizontal Mounting
- Fully upgradeable to ClearVision or ERO Camera Based Quality control solutions.



- Up to 16 channels in modules of 4 in any combination of sensors and valves
- Jam Preventer (up to 16 channels)
- Auto-configuring voltage 90-240VAC
- Internal Pressure Control (up to 4)
- External Pressure Control (up to 4)
- Easily recognized icon-based access to gluing inspection
- Job Storage (1000)
- Batch, supports tracking and all forms of ejection
- Inch/Metric
- 12" Remote-mount Color touch-screen
- Data sharing with CartonChek
- OEM Communication
- Auto-Glue mode
- Pulse-Purge
- Stitched patterns - jog on restart
- Scanner Lockout
- Quality data collection and reporting
- SupportChek remote service access
- Fully upgradeable to ClearVision or ERO Camera Based Quality control solutions.

MCP-B



- 8-Valves, 8-Scanners
- Jam Preventer (4 or 8 Channel)
- Auto-configuring voltage 90-240VAC
- Internal/External Pressure Control
- Job storage (100)
- Inch/Metric
- 4.5" Color touch-screen
- Alarm/Relay outputs
- Remote mount screen option
- Backup/Restore to/from external media
- Data sharing with CartonChek
- OEM Communication
- Auto-Glue mode
- Pulse-Purge
- Stitched patterns - jog on restart
- Scanner Lockout
- Batch Count
- Fully upgradeable to ClearVision or ERO Camera Based Quality control solutions.

MCP-8I



- 4-Valves, 3-Inspection Sensors, 1 ejector
- Jam Preventer (4 or 8 Channel)
- Auto-configuring voltage 90-240VAC
- Internal/External Pressure Control
- Job storage (100)
- Inch/Metric
- 4.5" Color touch-screen
- Alarm/Relay outputs
- Remote mount screen option
- Backup/Restore to/from external media
- Data sharing with CartonChek
- OEM Communication
- Auto-Glue mode
- Pulse-Purge
- Stitched patterns - jog on restart
- Scanner Lockout
- Supports kick, spray and linear ejector with tracking, no rotary ejection
- Fully upgradeable to ClearVision or ERO Camera Based Quality control solutions.



524 LN LR VALVE (LONG NOSE LOW RESTRICTION)

- Adjustable flow rate for precision high-speed patterns
- Integrated purge/test switch
- Capable of high pressure operation (up to 500 psi)
- Compatible with a range of adhesive viscosities (up to 4000cps)
- Extended nozzle body permits positioning close to machine rails for installation flexibility
- Low restriction nozzle for consistent quality restarts
- Ceramic on ceramic ball and seat
- Illuminated Purge Button for visual confirmation

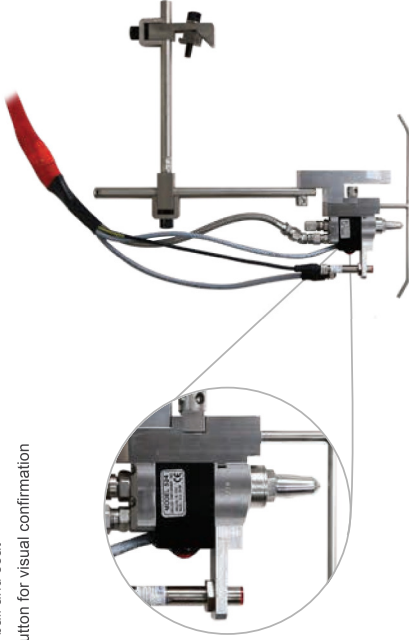

NEW FEATURE 524 VALVE WITH INTEGRATED VALVE ACTIVATION LED

- Integrated purge button
- Illuminated valve activation
- Allows operators to easily identify when the valve fires
- Assist with troubleshooting if the need should arise



BOTTOM UP GLUE STATION

- Can be installed on most folder-glueers
- All-electric high-speed precision glue valve
- Reduces adhesive usage
- Contact valve application for consistently clean pattern
- Eliminates maintenance and cleaning associated with glue pot
- Enhances machine performance and production versatility
- Glue detection available

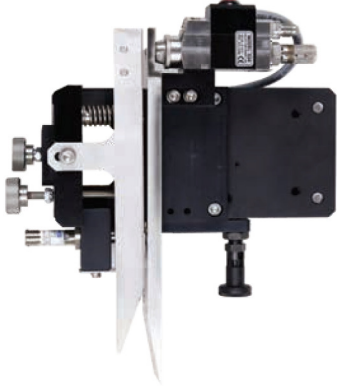

300 VALVE

- Precision glue patterns at all machine speeds
- Simple design with only 3 replacement parts
- Integrated purge/test switch
- Numerous mounting options
- Cost-effective, full featured high speed non-contact gluing



COST-SAVING

Fast and simple order setup/change over

FLEXIBILITY

Top-down or bottom up / high-pressure or low-pressure Contact or Non-Contact

LESS WASTE

Precise patterns with less glue consumption

VERSATILITY

Easily expand system capabilities as needs change

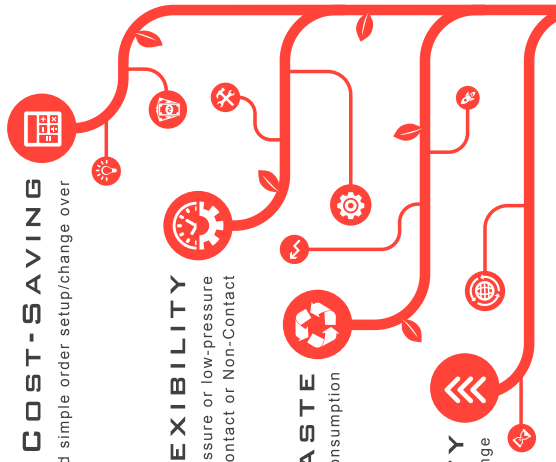

1:1, 3:1, 6:1 BALANCING REGULATOR



- Pressure balancing regulator - relieves excessive pressure that occurs during high speed stops
- Ultra-precise and fast pressure control
- No shaft seals
- Easy rebuild
- No pattern flooding at restart
- Rolling diaphragm design for frictionless movement and no losses

DD-1

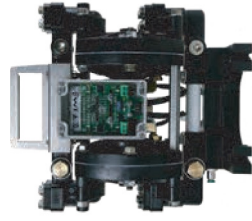

- Trusted reliability of a 1:1 diaphragm pump
- Electronic shifting
- High flow rate
- Suction from totes, drums, and pails
- 1/2 NPT and 1/2 BSPP inlet/outlet fittings
- 24VAC source from Vacco Melton controls or optional transformer
- Wall mount, pail mount, or drum mount

EPP-9



- High flow-rate 9:1 piston pump
- Electronic reversing
- Intelligent SLOW MODE feature prevents high cycle rates that occur during priming or when adhesive supply is blocked or depleted (dry cycling).
- Can communicate adhesive consumption and maintenance intervals with select glue pattern controllers
- Advanced seal technology offers extended reliability

PFM-5



- Complete assembled package, 14:1 pump, 5:1 pressure-balancing regulator, 4-port manifold, and filter
- Shaft/seal cartridge for fast and simple repair
- Drum mount, wall mount, and pail mount options

Central Gluing System

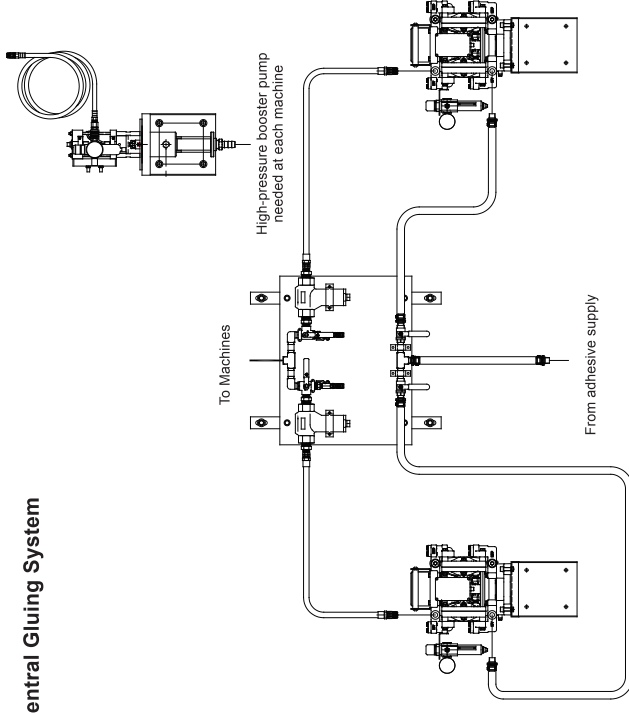

PERFECT PRESSURE
EVERY TIME

GEAR PUMP OR PISTON PUMP MELT UNITS

Valco Melton's D4, D10 and D16 Series Units are ideal for high speed folding carton applications. All D Series units feature an LED display, spur gear pump with fixed or variable speed, "key-to-line" control, and a multi-functional control system. Other options include an integrated glue pattern control, line speed pressure control and integrated auto-feed systems.

- Achieve uniform output pressure to match line speed with built-in pressure run-up control
- Easy-to-connect HMI communication through the melter interface I/O's

The EC series units design is a culmination of features that have been crafted in response to communication with hot melt unit users worldwide. Valco Melton's new EC Series hot melt adhesive unit offers optimum reliability and total control of the unit's operation. Supported by the most current features and technology, the Valco Melton EC series unit easily takes recognition as the best in its class.

- User-friendly control panel
- Air-powered piston pump

D Series Gear Pump Units
4, 10, 16 KG Tanks



EC Series Piston Pump Units
4, 8, 14 KG Tanks



MX SERIES VALVES, SIDE-FEED OR TOP-FEED

Valco Melton's MX electric hot melt valve is the workhorse for most Valco Melton hot melt dispensing solutions. The MX electric valve can operate at extremely high speeds reaching 15,000 cycles per minute for short bursts and are capable of more than 2 billion cycles before requiring service.

Combine the speed of hot melt with the strength of cold glue.

- Cost-effective solution
- Maximize production
- Clean application
- Fast system payback
- Side feed or top feed assembly

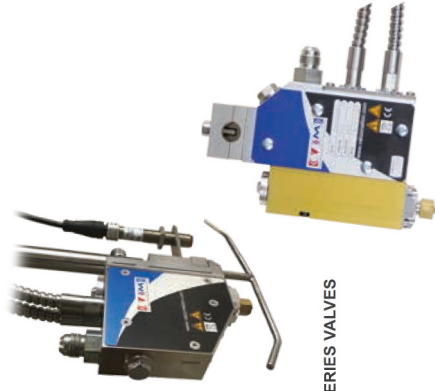

MX SERIES VALVES

MK-F SERIES INSULATED APPLICATORS

Designed for easy installation in constricted spaces, it's compact design makes it ideal for folding carton applications with limited space.

Air-open air-close zero cavity design produces clean adhesive shut-off for PUR and pressure sensitive adhesives.

- Minimal space required for installation and maintenance
- Sharp cut-off for a clean application – no adhesive stringing
- Specially insulated for safe handling
- Zero cavity design – extremely fast and accurate patterns

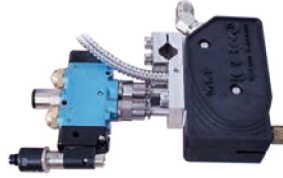

MK-F SERIES VALVE

PUR

Valco Melton's IsoMelt Mini and D4 PUR Series are designed to process reactive hot melts such as PUR. Units feature a fully integrated, multi-functional controller that is accessible from a user-friendly screen, which allows for fast and easy configuration changes and provides 'key-to-line' capabilities.

- Ideal for plastic packaging
- Swiveling tank lid allows for faster changes of PUR slugs, minimizing downtime

Also available with Pail Unloader

IsoMelt Mini



D4-PUR

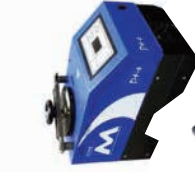

Pail Unloader



AS303/AS303H

- Fine Resolution: 1mm
- Compact Size: 21mm wide x 115mm tall x 60mm deep
- Functions with Quality Assurance Systems: CartonChek, VCX, MCP-8i
- High speed inspection for cold glue and hot melt adhesives
- No UV additive required
- Field of View (FOV): 8 to 10mm



BAR CODE READER

- Code 39
- Codabar
- Code 128
- Interleaved 2 of 5
- Code 93
- UPC / EAN / Pharma
- OMR (Optical Mark Recognition)



CGS-4DS

- Designed for side seam inspection
- Glue pot or closed system
- Indicator LED's for supply voltage and signal output
- Polymer enclosure with a smooth surface for minimal build-up and easy cleaning



DIGITAL SENSORS FOR CUSTOM DETECTION NEEDS

- Length and skew detection
- Flap detection
- Foil and window detection
- Label detection

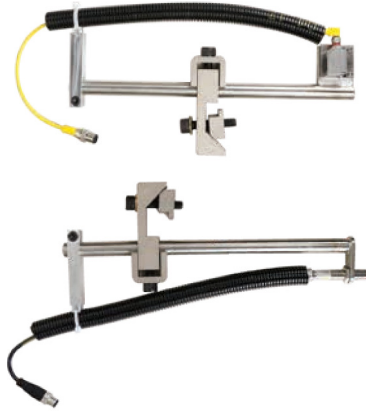

CDS CODE READER

The CDS code reader is an indispensable tool for high-speed production. The code reader reliably monitors color (including foil stampings) or black-and-white bar codes. The operator can set dimensional tolerances individually for code bars and spaces to provide simple or advanced quality standards. Valco's color-code-reading system provides inspection functions not possible with any other code reader.



The color code reader comes with a pre-folder. Because the code reader is mounted in the proper fixed position for quick sampling, make-ready time is substantially reduced. A dual color code reader is also available for carton applications that have print on both sides.

- Mixed copy
- Missing color
- Color density
- Print registration
- Die-cut registration
- Skew
- Double-feed
- Binary codes (including Bobst and Pharma)

POT FILL

- Valco Melton pot fill system will automatically maintain adhesive level without requiring operator attention

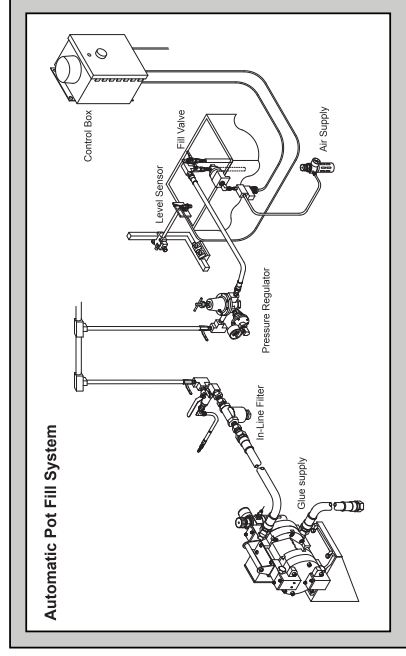

ROTARY & LINEAR EJECTOR

• Valco Melton offers high-speed linear and rotary ejector systems that will remove defective product before it can be processed

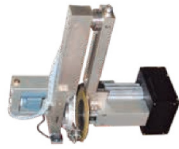

ROTARY EJECTOR

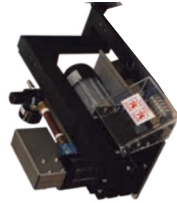

LINEAR EJECTOR



KICKER

The Valco Melton Kicker is ideally suited for batch counting and reject kicking applications. The kicker offers a fast cycle time for smaller cartons and compact design for flexible mounting requirements.

- Single kick eject
- Dual kick and count eject optional



MARKING VALVE

- Compact system package provides identification of faulty product
- Stainless steel tank
- All-electric, jetting or spray valve options
- Optional UV lamp kit



SYSTEM STANDS

Valco Melton offers several options for system stands. The system stand significantly reduces initial installation time and provides a clean, organized installation for improved operator interface.

- Floor mount, machine mount or optional casters
- Diaphragm pump or piston pump
- Single or multiple glue pressure regulators
- Selected for any common Valco Melton control

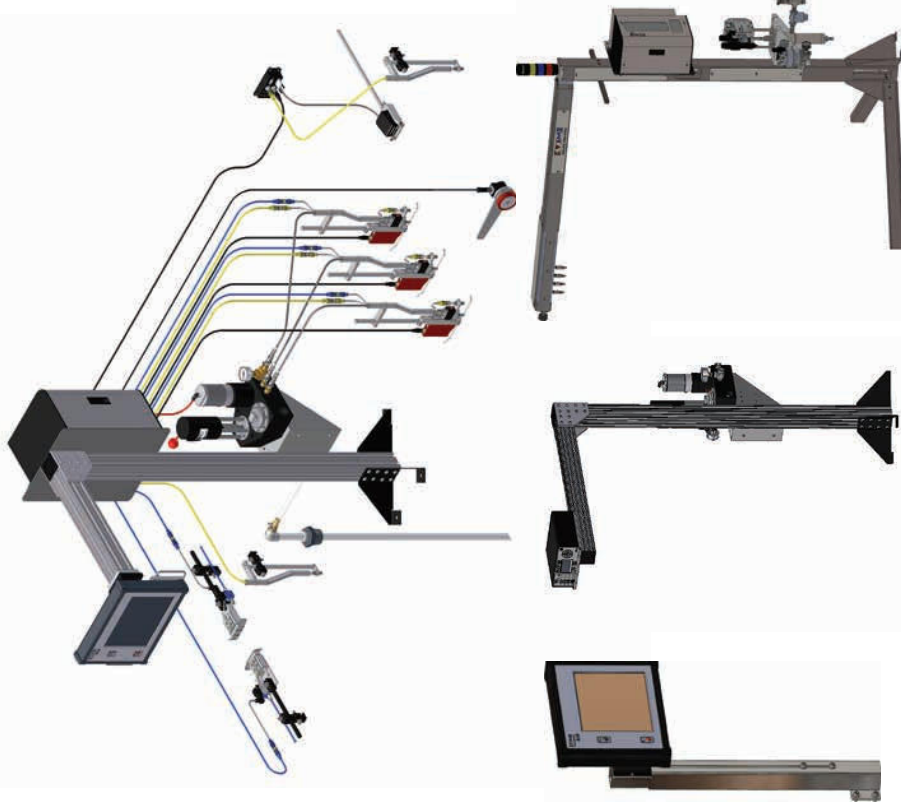

System stand options are available for any system configuration

CARTONCHEK

HOW IT WORKS

CartonChek brings users complete information on production line performance in real time. The screen simultaneously displays job statistics, defect images and history bar to facilitate analysis.



BENEFITS

- Detect and identify defective gluing (hot melt or cold glue), folds, barcodes, print registration, manufactures joint, as well as issues with sheets such as skew.
- Minimize configuration times with the system's ability to learn the position of the cameras and sensors.
- Streamline support sessions using the online chat window.
- Intuitive interface that displays real time images and data from each of the installed systems.
- Defect and performance data for all boxes stored locally in SQL database and can be easily accessed remotely with MeasurementChek for quick comprehensive reporting.

SOFTWARE PACKAGES

GLUECHECK

- Glue pattern
- Glue volume
- Extraneous glue splash or splatter
- Full sheet monitoring, glue patterns, flaps and fold verification

CODECHECK

- Eliminate mixed copy issues
- Validate most 1D (Linear) and 2D (Matrix) barcodes (Linear), 2D (matrix) and GSI barcodes
- Sequential data capture and barcode quality reporting.

LASERCHECK

- Height changes are inspected in order to recognize folds, flaps, and cut outs.
- Use LaserChek to check perforations, cut outs, tip-on (placement), die cuts or any point that requires a measurement or validation in-line

WINDOWCHECK

- Complete window inspection: height, width, position, contaminates, glue pattern & cello with slit are all measured or compared to Master Image
- Set and adjust multiple tolerances to detect various types of defects

BRAILLECHECK

- Decodes braille into text for accuracy and validation
- Identifies missing or misshapen braille dots

PRINTCHECK

- Print quality
- Color monitoring
- Print registration
- Missing print

MAKING QUALITY VISIBLE



NARROWCHEK

- Small footprint
- Simple to move and install
- Self Calibrating
- Ideal for tight space and glue sensor replacement. 60mm (2.3") Field of View.



AREACHEK

- Typically uses external lighting
- Best for permanent mount
- FOV: 40mm(1.57") x 40mm up to 200mm(7.87") x200mm



MICROCHEK

- Compact
- Built-in Lighting
- Simple to move and install
- Ideal for barcodes, object and number inspection



MEGACHEK

- Ideal for whole carton image
- Glue pattern, flaps, and fold confirmation
- Typically uses external lighting
- Best for permanent mount
- FOV: 125mm (5") to 800mm (31.5")



SHADOWCHEK

- Built-in lighting source
- Designed to create profile or shadow to define raised edges
- Ideal for braille, glue patterns, tip-ons and more



LASERCHECK

- Built-in lighting source
- Designed to create profile or shadow to define raised edges
- Ideal for glue patterns, tip-ons, cutouts, perforations and more



CLEARVISION
THE PERFECT CARTON

JOINING

FORCES

As world leading manufacturers and suppliers of adhesive dispensing and quality assurance systems for the folding carton industries, Valco Melton and ERO Gluing Systems jointly provide unparalleled solutions for hot/cold glue dispensing and quality inspection solutions that **Make Quality Visible**.

Valco Melton and ERO Gluing Systems combined provide a network of sales and technical support service that spans over 76 countries worldwide - all to make sure that **You Make the Perfect Carton**.

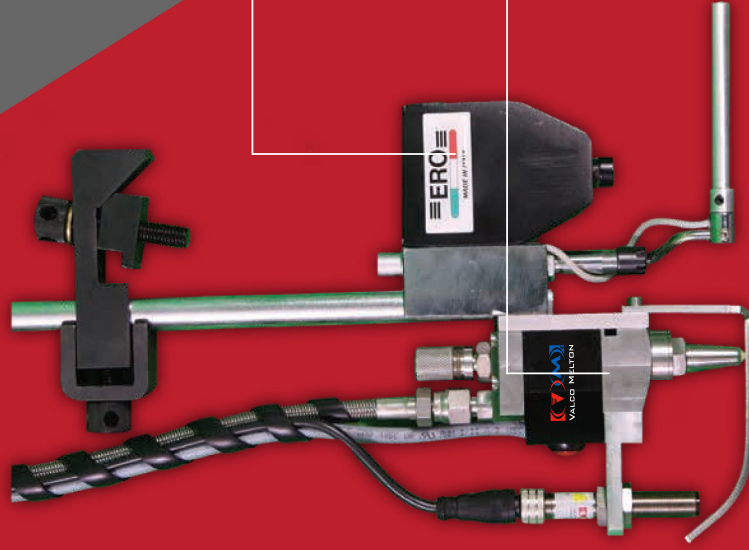

Compact gluing inspection camera

Compact inspection camera achieves a frame rate of 160 frames per second. Can be monitored in real-time from a control screen

Valco Melton 524 Valve

Ideally suited for high speed, single bead applications

Illuminator

A rounded, adjustable illuminator comes standard with the system

Established in 1952, Valco Melton is one of the world's leading suppliers of adhesive dispensing systems and quality assurance equipment across the corrugated, folding carton, paper converting, and graphic arts industries. Headquartered in Cincinnati, Ohio, its R&D and manufacturing facilities span across the USA, Canada and Europe



Located in Brescia, Italy, Ero, S.r.l. has been servicing the gluing needs of the paper converting industries since 1994. ERO® specializes in cold gluing and vision systems specifically designed to meet the unique dispensing requirements within the envelope, bag, corrugated and folding carton industries.

ERO TE

HIGH-PRESSURE GLUING SYSTEM

ERO-TE high pressure gluing system has been designed for normal and extremely high-speed folder-gluer machines.

- Extra high-speed production
- Low maintenance & easy handling
- Maximum reliability at high speeds
- Dot distribution mode for glue savings
- Wide range of options available
- Advanced technology at a competitive price

ERO-TE STANDARD FEATURES

- 4, 8, 16 channel control panel as standard (more channels available on request)
- High-pressure double-piston ERO® glue pump
- High-pressure ERO® flow regulator
- Digital proportional valve and air regulation group
- Complete device optionally equipped with check valve and low glue level alarm
- Encoder with support and pulley, laser photo-eye, glue filter, glue air hoses, pump support fitted with sliding device and cover
- Electromagnetic glue applicator type GTE-13/S
- Movable structure available as an option

Maximum speed of production: over 500 m/min.
Maximum error at 500 m/min: +/- 1 mm.
Dimensions: L = 400 mm, H = 1510 mm, W = 660 mm.
Weight: 60 kg

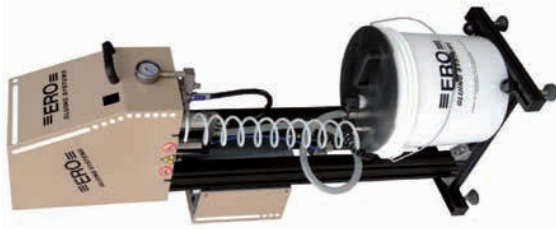

HIGH-PRESSURE DOUBLE PISTON GLUE PUMP

All ERO high-pressure systems are provided with a double piston glue pump. This pump has been specifically designed for the folding carton industry by ERO to tackle the pressure problems often inherent in other pumps. While most piston pumps on the market have a single piston, ERO pump features two. The second piston begins its stroke before the first one has finished, thus avoiding any pressure loss.

- No pressure loss allowed
- Leading technology at a competitive price
- Low maintenance & extra-high reliability
- Driven by an electrical board
- Easy seals replacement

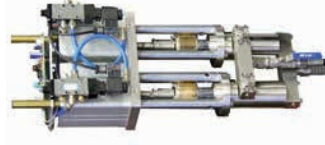

ERO TEPS

SIMPLIFIED LOW-PRESSURE GLUING SYSTEM

ERO-TEPS low-pressure gluing system has been developed for high-speed folder-gluer machines.

- High-speed production
- Low maintenance & easy handling
- Great reliability at high speeds
- Dot distribution mode for glue savings
- Advanced technology at a competitive price

The low-pressure gluing system ERO-TEPS is provided with electromagnetic glue applicators GTE-13 as standard. The dot distribution mode optimizes glue usage allowing savings by up to 40%.

ERO-TEPS STANDARD FEATURES

- 4, 8, 16 channel control panel as standard (more channels available on request)
- Low-pressure, double-diaphragm glue pump, directly installed on the glue bucket
- Low-pressure flow regulator
- Digital proportional valve and complete air treatment group
- Complete device optionally equipped with check valve and low glue level alarm
- Encoder with support and pulley, laser photo-eye, glue filter, glue air hoses, pump support fitted with sliding device and stainless steel cover
- Electromagnetic glue applicator type GTE-13/S
- Glue bucket with 250 micron glue filter inside
- Driver box and software



Maximum speed of production: over 250 m/min.
Maximum error at 250 m/min: +/- 1 mm.
Dimensions: L = 410 mm, H = 1200 mm, W = 770 mm.
Weight: 25 kg

ERO-TEM

MEDIUM-PRESSURE GLUING SYSTEM

The medium-pressure gluing system has been developed for extra high-speed folder gluer machines.

- Extra high-speed production
- Low-maintenance & easy handling
- Maximum reliability at high speeds
- Dot distribution mode for glue savings
- Advanced technology at a competitive price

ERO-TEM STANDARD FEATURES:

- 4, 8, 16 channel control panel (as standard (more channels available on request))
- ERO® glue pump
- ERO® flow regulator
- Digital proportional valve and air treatment group
- Complete device optionally equipped with check valve and low glue level alarm
- Encoder with support and pulley, laser photo-eye, glue filter, glue air hoses, pump support fitted with sliding device and cover
- Electromagnetic glue applicator type GTE-13/S
- Movable structure available as an option



ERO® control devices can drive both pneumatic (contact) and electromagnetic (non contact) glue applicators. They are able to activate both hot glue guns and cold glue valves even if they are installed on the same machine.

ERO CONTROLS STANDARD FEATURES:

- 8 channels control panel (as standard)
- Up to 8 glue patterns configuration for each channel/glue distributor
- Mother board expansion available
- User-friendly operating

ERO

CONTROL DEVICES



IPAD

iPad is an upgrade from the standard and traditional control panel, allowing independent monitoring.

The gun cleaning manual test can be carried out from an iPhone.

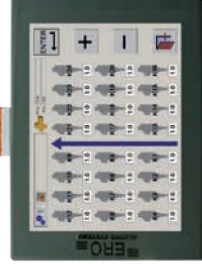

TOUCHSCREEN

The standard touch screen features an intuitive interface to help the operator with the programming labor.



CONTROL PANEL

The user-friendly control panel monitors ERO sensors.

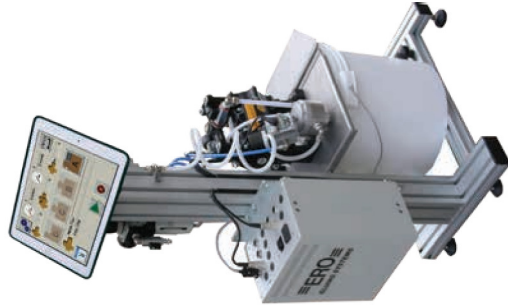

ERO-TEBS

LOW-PRESSURE GLUING SYSTEM

ERO-TEBS

The upgraded low-pressure version ERO-TEBS with support provided with the most important high quality items of the high-pressure version. Available as an affordable option, it is equipped with a structure and a sliding device on the pump to guarantee an easy glue refill of the bucket.

GTE-112H electromagnetic distributor has been studied for hot melt applications working at high speeds.

- Maximum speed: 300 cycles per second
- High thermal conductivity material
- Dot distribution mode for glue savings
- Slides for automatic nozzle cleaning
- Ceramic sphere and nozzle

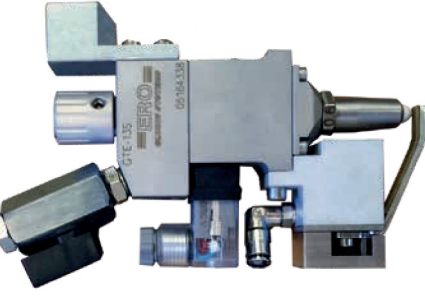

GTE 112H

Maximum glue pressure: 60 bar
Dimensions without support or accessories: L = 75mm, W = 20mm, H = 22mm
Weight: 0,670 Kg
Power: 5 W
Resistance: 175 W
Probe: PT 100
Standard coil: 7 VDC, 5W,
Standard nozzle: 1 hole Ø 0.4 mm (available size: 0.3, 0.6 and 0.8 mm)
Maximum glue pressure: 60 bar
Maximum glue viscosity: 2000 mPaS
 The gluing system is tested at an air temperature of 20°C with 900 mPaS glue viscosity.
 Suggested viscosity range: from 500 to 1000 mPaS



Made of high thermal conductive material with ceramic stem sphere and nozzle, the GTE-112H applicator prevents glue blockage within and outside the nozzle.

GTE-112H dot distribution mode allows considerable glue savings. The dispensed glue amount can be adjusted by setting the knob on the head of the gun.

The hot melt glue distributor can be driven by the ERO® standard control panel and installed in any new or existing system. As an option, an auto-cleaning slide can be installed on this glue dispenser. Each hot melt glue distributor is provided with an adjustable bracket.

GTE-112H modular glue gun can feature up to 4 guns in 1 block on the line in the rear and up to 4 guns more in the front.

The GTE-13S and GTE-13M single and modular applicators can operate at the highest speeds. These non-contact electromagnetic guns can reach 210 m/min when working in dot mode.

- Dot distribution mode for glue savings
- High precision and maximum cleaning
- Slides for automatic cleaning nozzles as optional
- 24 VDC and 6 VDC coil available
- Infrared photo-eye installed on each glue dispenser

GTE 13/S & GTE 13/M

ERO® electromagnetic glue distributors type GTE-13 feature ceramic stem spheres and nozzles that prevent and inhibit glue blockage.

Slides for automatic cleaning are available as an option. When no box is detected by the machine for more than 1 second, sliders automatically closes and clean the nozzle.

GTE-13 guns can apply in dot-mode in order to save a considerable quantity of glue while preserving the bonding quality.

Maximum speed: 1000 cycle/sec
Dimensions without support or accessories: L = 52mm, H = 122mm, W = 20mm
Weight without support or accessories:
GTE-13/S: 0,300 Kg
GTE-13/M: 0,320 Kg
Power: 5 W
Standard coil: 6 VDC
Standard nozzle: 1 hole Ø 0.4 mm (available size: 0.6 and 0.8 mm) and 2 holes nozzle
Maximum glue pressure: 28 bar
Minimum cycle time: 0,6 m/sec
Glue viscosity range: Min. 500 mPaS, Max. 1200 mPaS



GTE-13S distributors can apply traditional beads or dots to reduce glue consumption

Distance between distributors at GTE-13M modular applicator can be adjusted from 0 to 20 mm



ERO-MSC glue inspection system detects any defect in the applied gluing pattern and provides real-time images of the faulty boxes for an in-depth defect analysis. ERO-MSC can inspect both cold glue and hot melt adhesive patterns.

- Extra high-speed inspection
- Reports in real time
- Reliable and easy handling
- Smart design
- Compact size

ERO MSC

COMPACT GLUE INSPECTION CAMERA SYSTEM



The extra-slim black & white camera width measures the same as the glue applicator. Along with the magnetic bracket, it can be easily mounted and handled in any production line, no matter how narrow the space is.

The system comes standard with support, illuminator, photo-eye and cables. Glue valve brackets are available for any competitor glue application solution to utilize the magnetic capability built into the Slimline camera.



ERO-MSC inspection camera is monitored and driven by a proprietary touch screen and displays pictures in real time. A data analyser, an encoder frequency divisor and a stroboscopic illuminator are installed inside an electrical cabinet.

ERO-BC and ERO-CBC reads barcodes printed on any package, even with white background, and verifies that every single package contains the correct barcode. ERO-BC checks black and white codes while ERO-CBC reads color codes.



ERO BC

BLACK & WHITE CODE INSPECTION SYSTEM



ERO CBC

COLOR CODE INSPECTION SYSTEM

All barcode reader systems are monitored and driven with a 12" touch screen. A data analyzer, an encoder frequency divisor and a stroboscopic illuminator are installed inside an electrical cabinet. The color camera analyzer can be connected to color cameras only and the black & white analyzer must be connected to black & white cameras.

BLACK & WHITE AND COLOR CAMERA SYSTEM FEATURES

- 640X480 pixels resolution camera, over 120 frames/sec.
- Maximum speed of 400 m/min
- Up to 4 connected cameras

*Both camera and system are equipped with support, illuminator, photo-eye, cables and various.

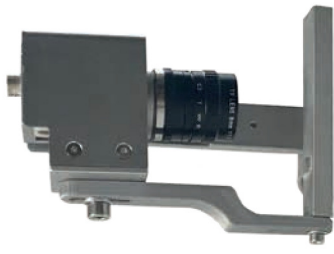

Sample of black & white bar code detected by BC Camera system, equipped with black & white camera.

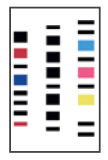

Sample of color, anti-mixed and black & white codes detected by CBC system, equipped with color camera.

ERO-SIT sensor verifies that a correct glue pattern has been applied to every carton and guarantees a perfectly glued box.

Based on a moisture sensor concept, the system analyzes the level of humidity in the glue applied on each box and compares it to the set tolerance range to identify good and non-conforming boxes. Additionally, it can identify excess, shortage and absence of glue on the boxes.

- High-speed production: over 700 m/min
- Complete underneath installation
- 100% guaranteed control
- Top technology at a competitive price
- Compact design

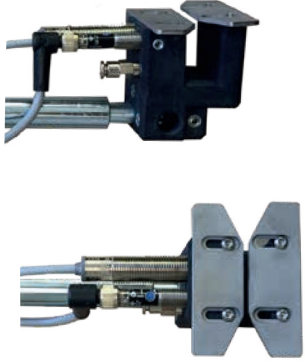

ERO SIT

EXTRA HIGH-SPEED GLUE INSPECTION SENSOR



ERO WSI

EXTRA HIGH SPEED WINDOW INSPECTION SYSTEM

ERO-WSI checks that every film is correctly placed on the window box, detecting missing films, holes and bad positioning.

- Extra high-speed production
- Control 100% guaranteed
- Advanced technology at a competitive price
- Smart and user-friendly control panel
- Compact design



The system can be equipped with 1 or 2 photo-eyes



ERO-BR verifies that every braille code is correct and conforms to a previous referenced sample.

In case a faulty box is detected by the system, the image can be displayed by pressing the appropriate key. Up to 200 images can be saved by the system.

All ERO braille inspection systems are monitored with a 12" touch screen. A data analyser, an encoder frequency divider and a stroboscopic illuminator are installed inside an electrical cabinet.

ERO BR

BRAILLE INSPECTION SYSTEM



ERO-BR SYSTEM STANDARD FEATURES

- Black & White camera 640X480 pixels resolution, over 90 frames/second
- High-efficiency stroboscopic flash camera
- Illuminator driver
- Encoder divider
- Low noise
- Extractor, kicker and marker drivers available

CAMERA INSPECTION SYSTEMS WORKING PRINCIPLE

All ERO® camera inspection systems for glue, bar code and braille inspection are based on the same working principle.

By running a properly glued box under the glue inspection camera and through the auto-learning system, the device takes a picture of the reference sample. The system memorizes the parameters and compares the sample to all boxes running through the machine.

When a box out of the set tolerance thresholds is detected, it is identified as faulty by the system and can be marked and ejected out of the production line. This guarantees a consistent glue pattern and correct bar codes and braille impression on every box.

MARKER & EJECTOR FOR FAULTY BOXES

As standard, all the ERO® camera and sensor inspection systems can stop the line or feeder after a number of faulty boxes previously set has been reached. Optionally, marker device, extractor and kicker keep the production line free from faulty product.

Available on request.



Tank and marker valve



Extractor for small boxes

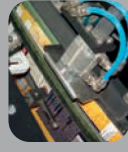

Kicker